

DATA ACQUISITION SYSTEM

omniace III

RA2300A / RA2800A



“Measurement by Anybody, at Any Field and Any Time!!”
The New-Generation Omniace



RA2300A

RA2800A



NIPPON AVIONICS CO.,LTD.

An NEC Group Company

- Easy Data Recording at Various Fields!!
- Long-term Recording on Built-in HDD!!



RA2300A



RA2800A

The RA2300A/RA2800A Omnicore III is a data acquisition device that enables you to acquire/record data with simple operation. Reduced condition setting time and easy measurement can be realized by virtual amplifier setup, a touch-panel and dynamic waveform display on a large LCD. The RA2300A/RA2800A features with various measuring modes such as HD Recorder (for long-term recording on a 40GB HDD) or Memory Recorder (for fast-speed event recording). The RA2300A/RA2800A will bring you success in many measuring opportunities such as production line, quality inspection and R&D.

Direct sensor inputs up to 32 channels (16 slots) are available for RA2800A and 16 digital input channels measure diverse signal timing and contact status.

FEATURES

■ Easy pen recorder mode

Easy operation of the “pen recorder” was realized by virtual amp. setup display and touch panel.

Easy measurement of a “pen recorder” is yours without complicated settings.

■ Various features at playback mode

Various search functions are available for finding certain points in large data easily after long-term recording. Fast search using a thumbnail bar (displays all recorded data of selected one channel) and jump search(max/min, time, etc.) available.

■ Direct input from sensors

Signals from various sensors can be input directly using 11 amplifiers(voltage, strain, temperature, vibration, pressure, rotation pulses, etc.)

■ Display input waveform on a large screen

A large 12.1” LCD for better visibility of measured data.

Horizontal and vertical waveform scroll is selectable for RA2800A and this function increases visibility.

■ Long-term HDD recording

Long-term & high speed data recording by a built-in 40GB HDD(data capacity of 120 days when using 16 channels with 10ms sampling speed).

■ Standard LAN & USB ports

LAN(100BASE-T) for data communication and USB for external storage devices(USB memories) are standard interfaces.

Supporting Measurement at Various Fields(Operation & Displays)

Dynamic waveform display

This system has large 12.1 inch LCD and shows dynamic waveforms. Displaying number and dividing waveforms are voluntarily settable so that various waveforms to every application are available.

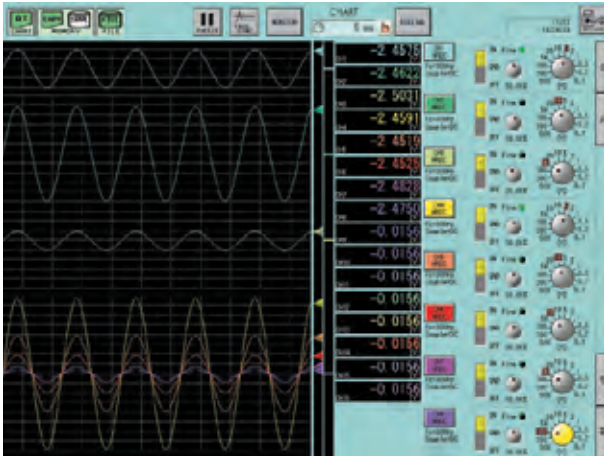

RA2300A Numerical value + amp setup display

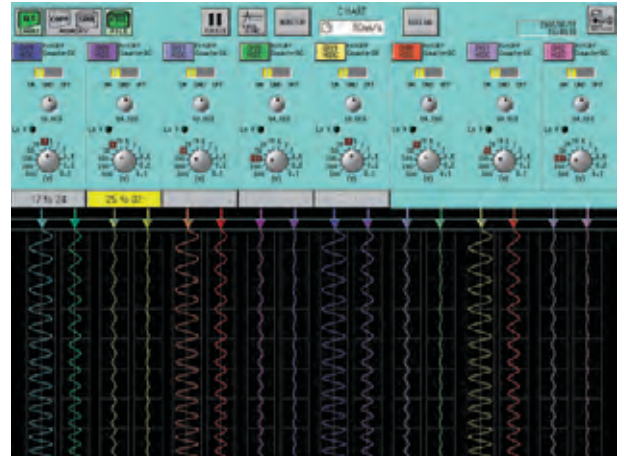

RA2800A Image of divided waveforms and vertical scroll

Easy operation with rich features

Setup displays with virtual mechanical switch or jog dial allows users to understand input amplifier settings easily. By using both 12.1" large LCD and the touch panel, measuring conditions can be modified while monitoring waveforms at the large display. The input amplifier can also be automatically tuned by "auto" button on actual operational panel.

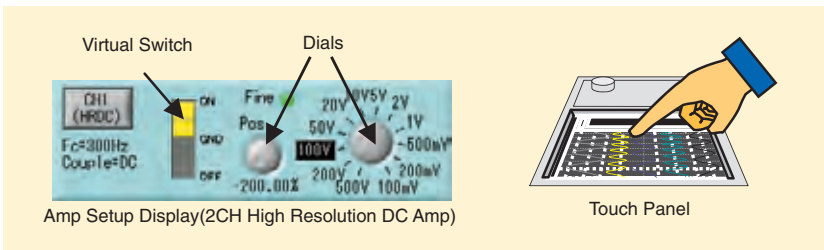

Amp Setup Display(2CH High Resolution DC Amp)

Touch Panel



"Auto" button

Operation Panel

Direct input from sensors



11 types of AP amplifiers including voltage, temperature, strain, vibration and frequency (pulse)are available and they enable every signal to direct input.

Item	Model No	Sampling	Resolution	Description
2-ch High Resolution DC Amp	AP11-101	10μs	16-bit	DC amp for high resolution measurement
2-ch High Speed DC Amp	AP11-103	1μs RA2300/2μs RA2800	12-bit	DC amp for high speed measurement
2-ch Zero Suppression Amp	AP11-111	10μs	16-bit	DC amp for gaining signal changes by eliminating offset element of input signals
2-ch FFT Amp	AP11-102	10μs	16-bit	DC and vibration amp to prevent high frequency loop-back
Event Amp	AP11-105	1μs RA2300/2μs RA2800	N/A	Amp for recording open/close for contact or H/L for voltage
2-ch TC/DC Amp	AP11-106A	10μs	15-bit	Input amp for thermocouple(R, T, J, K and W) and voltage
TC/DC Amp	AP11-107	10μs	14-bit	1-ch input amp for thermocouple(R, T, J and K) and voltage
2-ch AC Strain Amp	AP11-104A	10μs	16-bit	Strain amp which reduces influence of external noises(AC bridge system)
2-ch DC Strain Amp	AP11-110	10μs	16-bit	Strain amp with DC bridge system
2-ch Vibration/RMS Amp	AP11-109	10μs	16-bit	DC/vibration amp for measuring signals in RMS
F/V Converter	AP11-108	10μs	16-bit	Amp for converting frequency (pulse) into voltage

User Selectable Measuring Modes

Users can easily select from five (5) Measurement Modes - Pen Recorder mode for real time strip chart recording, HD Recorder mode for long term recording of data to a HDD, X-Y Recorder mode for displaying/recording X-Y correlation of two signals, a Multi Recorder mode captures transients while recording steady-state signals, and a Memory Recorder mode for recording fast events.

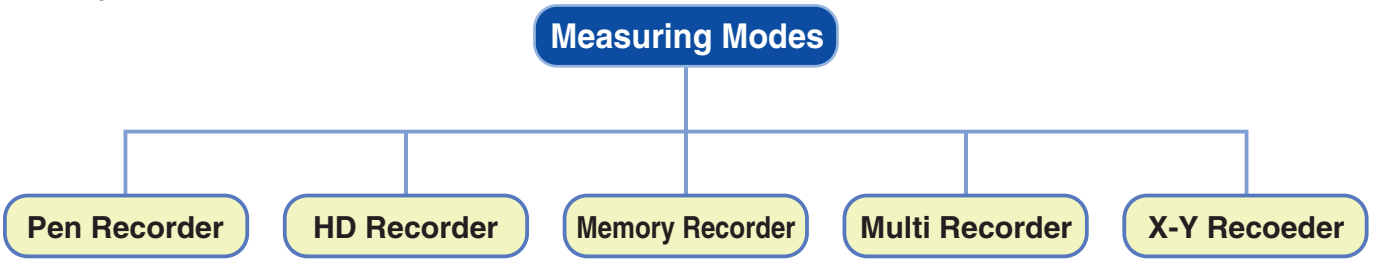

Easy “Pen Recorder”

The “Pen Recorder” is a measuring mode with simple operation of pen recorders. The waveforms are displayed with “moving nib” images. Also, like pen recorders, amplifier and paper feeding speed* can be setup on the touch panel.

* RA2300A chart speed : 100mm/s ~ 1mm/min RA2800A chart speed : 50mm/s ~ 1mm/min

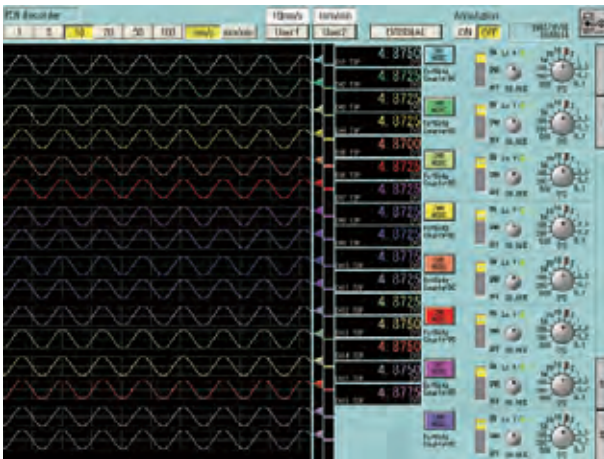

RA 2300A display sample

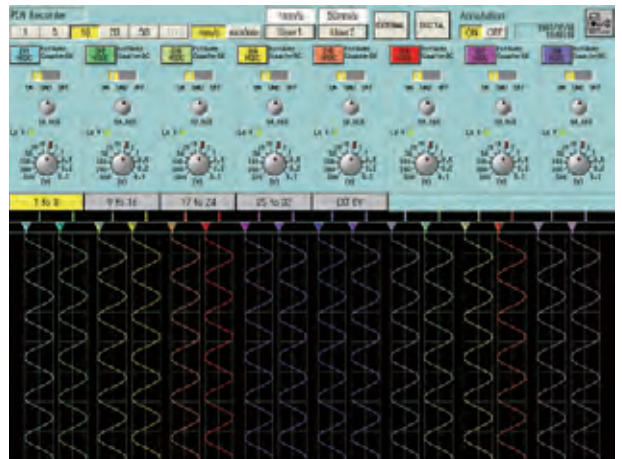

RA2800A vertical display sample

“HD Recorder”: Best for Long-term Recording

Long-term data recording is available on a standard built-in HD(40GB*1). Fast speed recording can be done at 1μs with 1 channel and at 10μs with 16 channels. Since data is digitally saved, post-record analysis or long-period management of data, which is not an option for recording paper, is possible.

Sample or peak style is selectable in recording. Peak style enables to have faster sampling data with max/min value than recording interval so that it can record data in slow recording interval.

*1 5GB is occupied by system.

Recordable Time on HardDisk²

Sampling Speed	2 GB Capacity ⁵			35 GB Capacity		
	w / 1 channel	w / 16 channels	w / 32 channels ⁴	w / 1 channel	w / 16 channels	w / 32 channels ⁴
³ 1μs	16.7 min	N/A	N/A	4.86 hrs	N/A	N/A
2μs	33.3 min	N/A	N/A	9.72 hrs	N/A	N/A
5μs	1.39 hrs	N/A	N/A	24.3 hrs	N/A	N/A
10μs	2.78 hrs	10.4 min	N/A	2.03 days	3.04 hrs	N/A
20μs	5.56 hrs	20.8 min	10.4 min	4.05 days	6.08 hrs	3.04 hrs
50μs	13.8 hrs	52.1 min	26.0 min	10.1 days	15.2 hrs	7.59 hrs
100μs	1.16 day	1.74 hrs	52.1 min	20.3 days	1.27 day	15.2 hrs
200μs	2.32 days	3.47 hrs	1.74 hrs	40.5 days	2.53 days	1.27 day
500μs	5.79 days	8.68 hrs	4.34 hrs	101 days	6.33 days	3.17 days
1 ms	11.6 days	17.4 hrs	8.68 hrs	203 days	12.7 days	6.33 days
2 ms	23.1 days	1.45 day	17.4 hrs	405] days	25.3 days	12.7 days
5 ms	57.9 days	3.62 days	1.81 day	1013 days	63.3 days	31.7 days
10 ms	116 days	7.23 days	3.62 days	2026 days	127 days	63.3 days

² It's a calculated value by integral number in sampling filing. Recording time will be half in peak filing.

³ Sampling speed 1μs is available for RA2300A only.

⁴ 32ch is available for RA2800A only.

⁵ Recording data is saved by every 2 GB for file protection.(in case recording data is set over 2GB)

“Memory Recorder”: For Fast Event Recording

This mode is for recording fast events with internal memories^{*1}. Unused memories can be utilized, so maximum of 32MW is available for memory recording if used only one channel. Measurements under various conditions are also possible by using many trigger functions.

*1 RA2300A memory : fastest 1μs by 2MW/CH

RA2800A memory : fastest 2μs by 1MW/CH

● Trigger Mode

OR : Activates if signal of ANY selected channel reaches trigger level.

AND : Activates if signals of ALL selected channels reach trigger level.

WINDOW : ... Activates if signal of selected channel(s) reaches preset level (IN) or gets out of it (OUT).

● Pre-trigger Function

This function allows user to memory-record data before trigger point. Extent of pre/post trigger point can be preset as proportion of total available memory size.

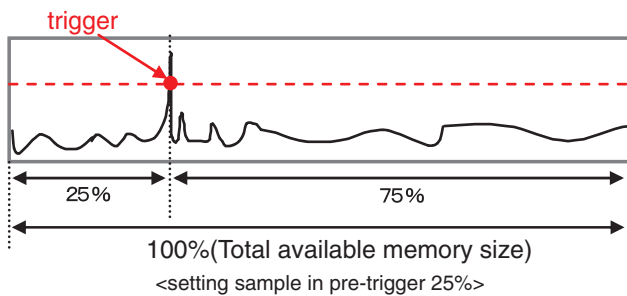

● Memory Block

As memory blocks are segmented, recording time is segmentalized and several recording functions are repeatable.

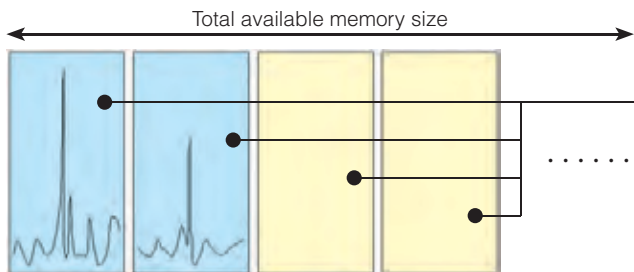

Recordable Time on Memories^{*2}

Sampling Speed	w / 1 ch (32 MW)	w / 16 chs (2 MW / ch)	w / 32 chs ^{*4} (1 MW / ch)
	³ 1μs	33.6 sec	2.10 sec
2μs	1.12 min	4.19 sec	2.10 sec
5μs	2.80 min	10.5 sec	5.24 sec
10μs	5.59 min	21.0 sec	10.5 sec
20μs	11.2 min	41.9 sec	21.0 sec
50μs	28.0 min	1.75 min	52.4 sec
100μs	55.9 min	3.50 min	1.75 min
200μs	1.86 hrs	6.99 min	3.50 min
500μs	4.66 hrs	17.5 min	8.74 min
1 ms	9.32 hrs	35.0 min	17.5 min
2 ms	18.6 hrs	1.12 hrs	35.0 min
5 ms	1.94 day	2.91 hrs	1.46 hrs
10 ms	3.88 days	5.83 hrs	2.91 hrs
100 ms	38.8 days	58.3 hrs	29.1 hrs

*2 It's a calculated value by integral number in sampling filing. Recording time will be half in peak filing.

*3 Sampling speed 1μs is available for RA2300A only.

*4 32ch is available for RA2800A only.

“Multi Recorder”: Records Steady-state & Transient Events Simultaneously

Chart printing, and recording to HDD and Memory can be simultaneously performed in this mode. A steady-state signal can be printed or recorded on the HDD while the system captures high-speed transient events to memory.

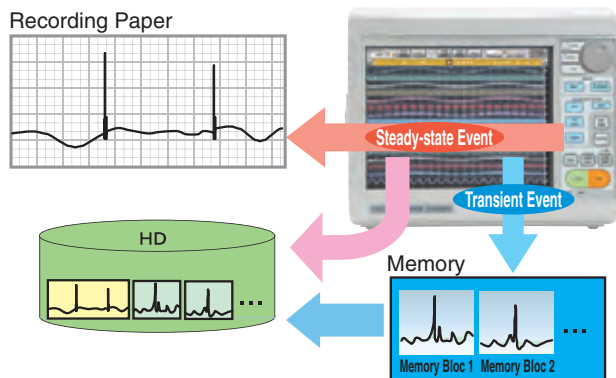

“X-Y Recorder”: Displays Correlation of Two Physical Values

Select any channel as the X input and up to 3 channels for the Y input. Signals are recorded and can be plotted for display and printing with high resolution(1600 x 1600 dots).

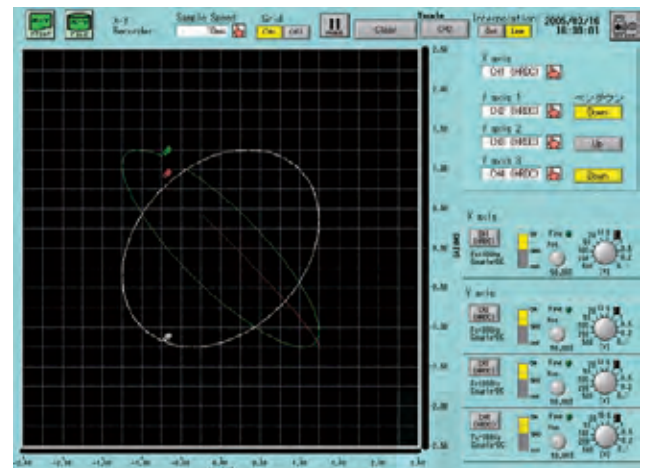

High Speed & High Resolution Recording

- High speed* and high resolution(80 dots/mm at 25mm/s) recording is available.
 - Customizable waveform division & printing size.
 - Location and amplitude of digital signals can be changed by 8 channels.
- * Paper-feed speed of RA2300A is max 100mm/s and that of RA2800A is max 50mm/s.

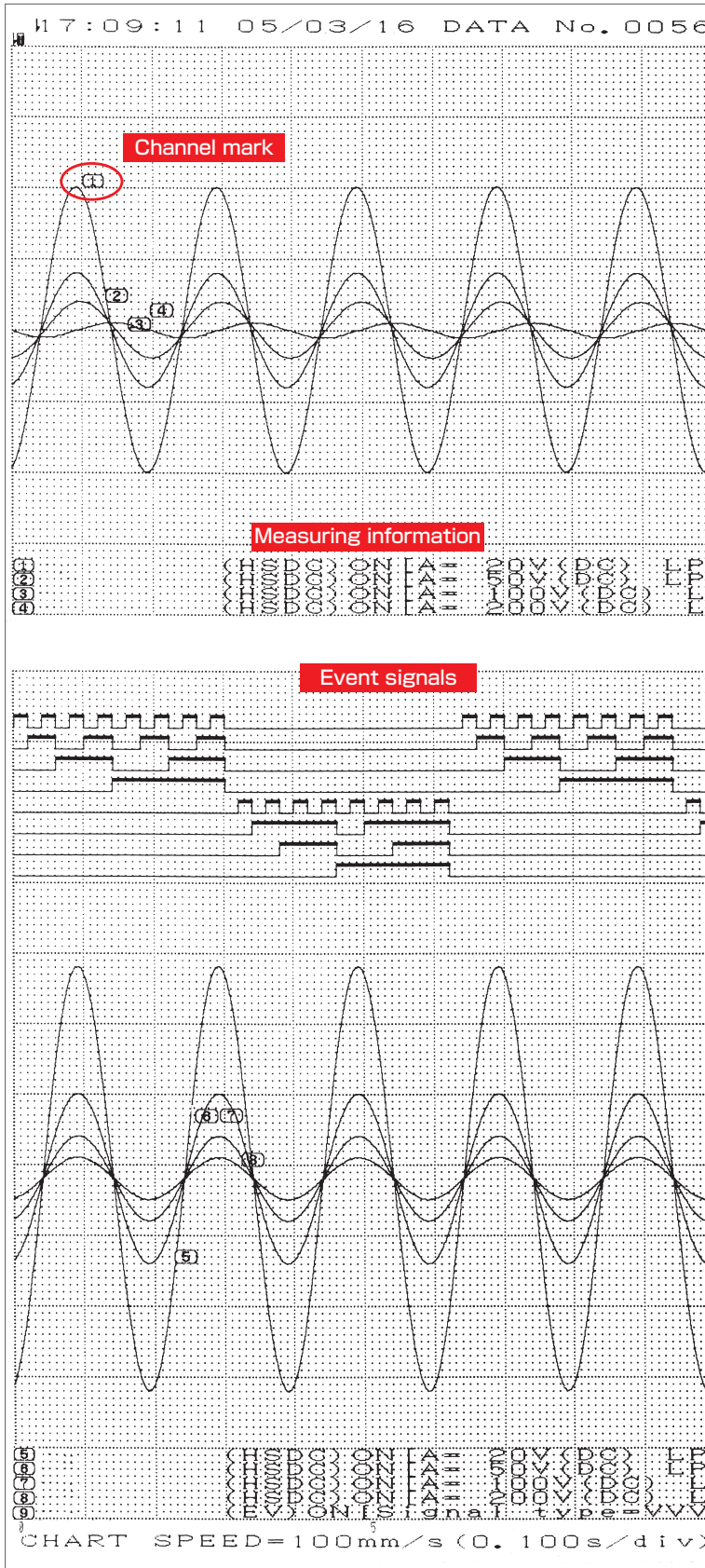

● Auto Scaling

Scales can be printed after waveforms.

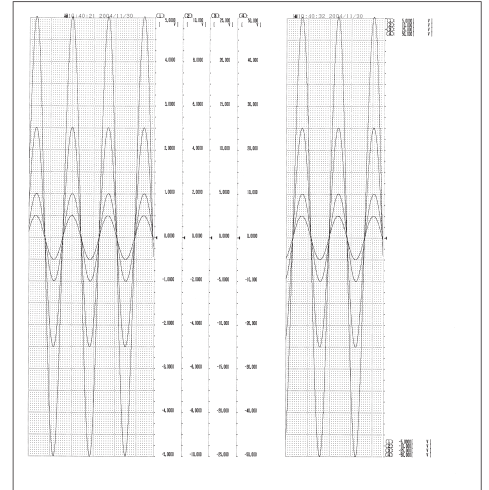

● Waveform Division

One to sixteen divisions can be selected to display or print out.

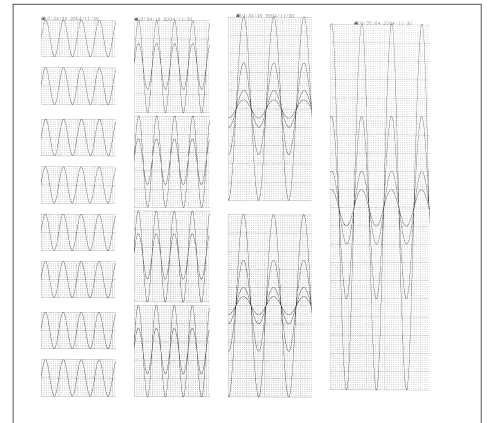

● Customizable Width Size

Users can print waveform at selected width(10 mm to 200 mm).

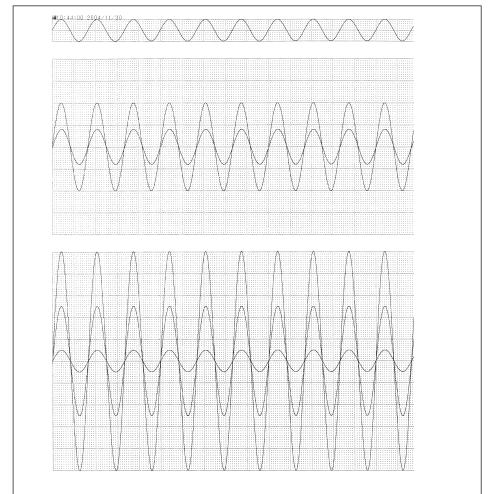

Various Features (Replay Monitor)

Easy Search of Large Data

Below functions are available for searching long-term and large data easily.

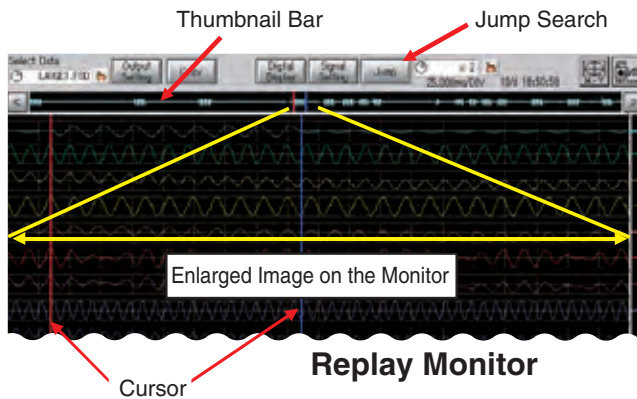

Thumbnail Bar :

This function displays a waveform image (one selected channel) of recorded data on a thumbnail bar. It does not only allow users to see whole waveform image easily but to get enlarged by touching.

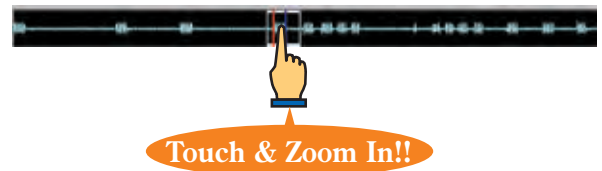

Jump Search :

There are four jump search modes as followings.

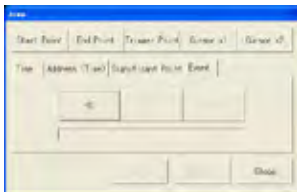

■ Event...
Move to marked event

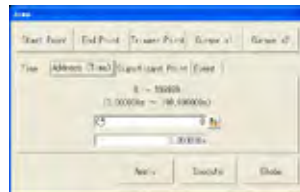

■ Address(Time)...
Move to elapsed time from start



■ Max/Min...
Move to max/min of recorded data

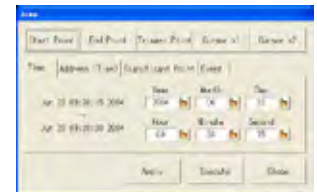

■ Time...
Move to specified time

Useful Functions

Saving Large Data on External Devices

RA2300A/2800A has two USB ports as standard. Measured data can be saved on external storage devices via USB.



Automatic Shutdown at Blackout

By connecting to uninterruptible power supply (UPS), RA2300A/2800A will be automatically shut down at blackout. If power failure occurs during long-term measuring, RA2300A/2800A will receive a signal from UPS and power itself off after regular shutdown.

*** This function requires an optional RS-232C Unit.

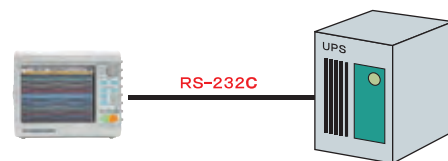

Timer-control Function

Automatic measurement with preset time and interval.

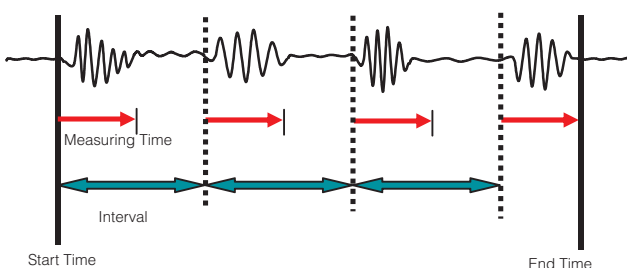

CSV File

RA2300A/2800A can convert measured data into CSV file for analysis using Excel or other analysis software such as MATLAB, FAMOS and DIAdem. It has functions like thinning out and batch conversions.



Options and Utilities

Remote Control by PC Software - Unifizer NS3000 Series

This PC application software enables the user to remotely program set-up configurations, record data, make arithmetic computations, and analyze data.

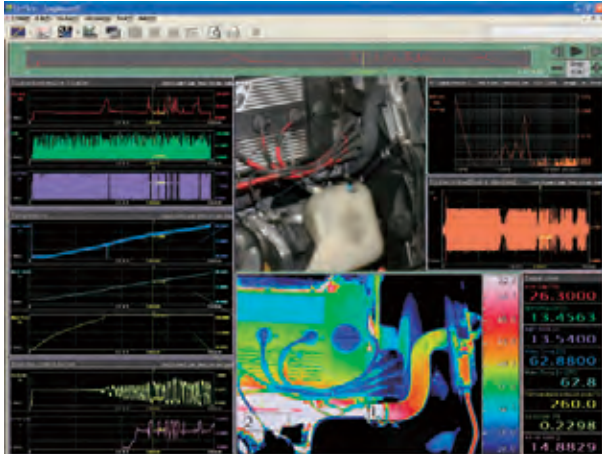

◆ Remote Control Feature

Remotely control all RA series units via Ethernet. Control mainframe data acquisition functions, signal conditioning amplifiers, IR thermal imager and NEC-ATI approved A/D boards and visible light cameras.

◆ Multiple Mathematic Operations and FFT Analysis

Math operations including Arithmetic/Trig/Log/Calculus functions and FFT real-time and post data collection analysis is included.

◆ User Defined Monitor Display

Monitor display of Digital, Y-T & X-Y, and Bitmap data can be freely customized by user.

◆ Report Generator and Simplified Print Feature

Comments and Cursors are easily added to the display monitor and printed.

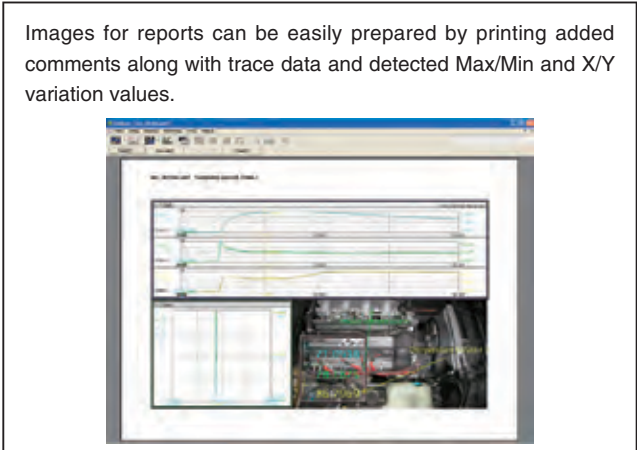
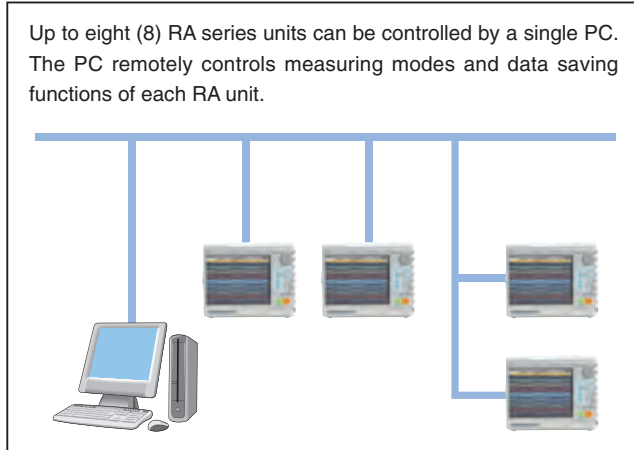

Expanded Mathematic and FFT Analysis Software – Model RA23-751

The RA23-751 software computes math operations (arithmetic/trig/log/calculus and FFT analysis) on recorded channel data and displays the results in tabular, or waveforms in time axis and frequency form, and saves the results.

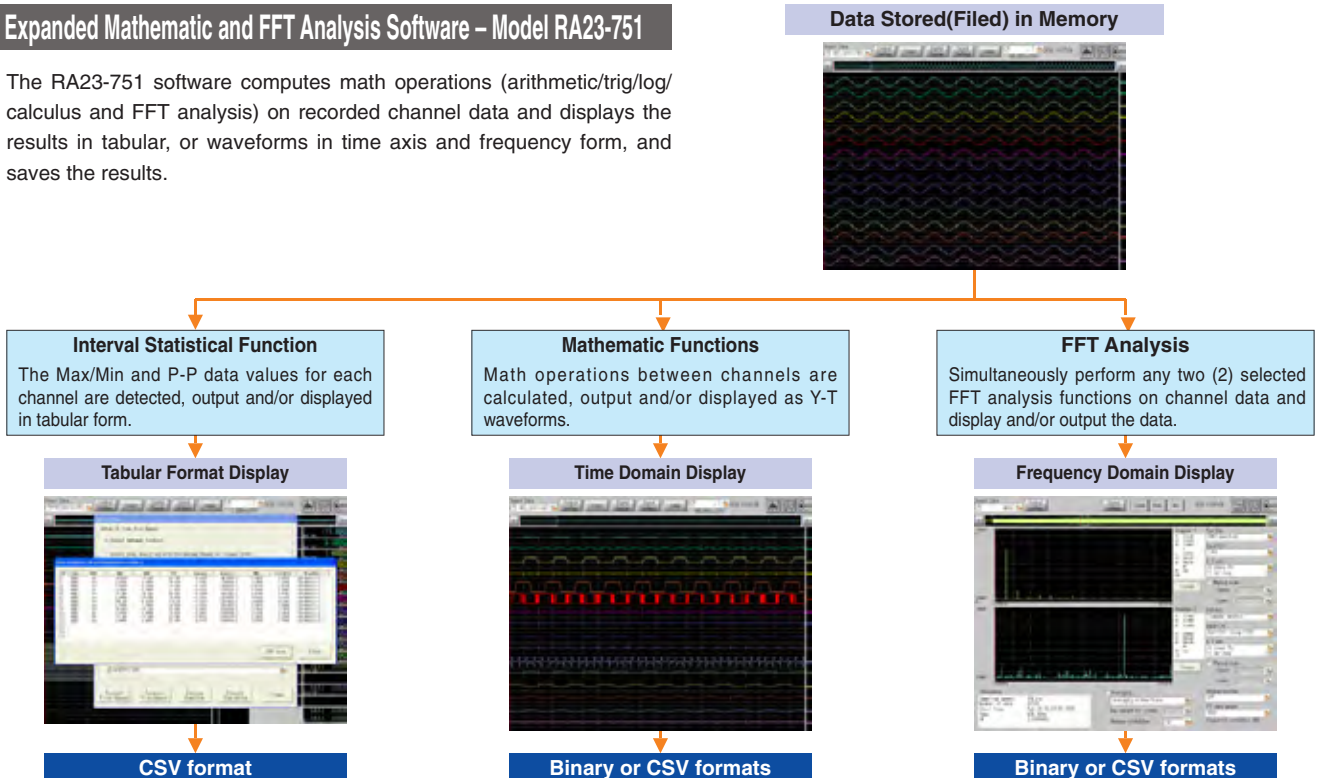

Multiple Unit Synchronization – Model RA28-132 (Model RA2800A units only)

The Model RA28-132 Synchronization option allows multi-channel memory recording among multiple connected Model RA2800A units. Up to 10 units can be daisy chain connected to expand channel capacity to 320 channels. One unit is a master and the others are slaves. All recorded data is time synchronized with the sampling clock of the master unit.

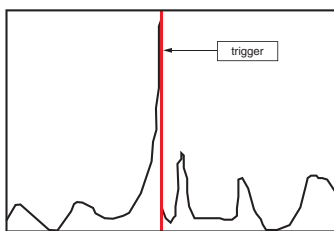
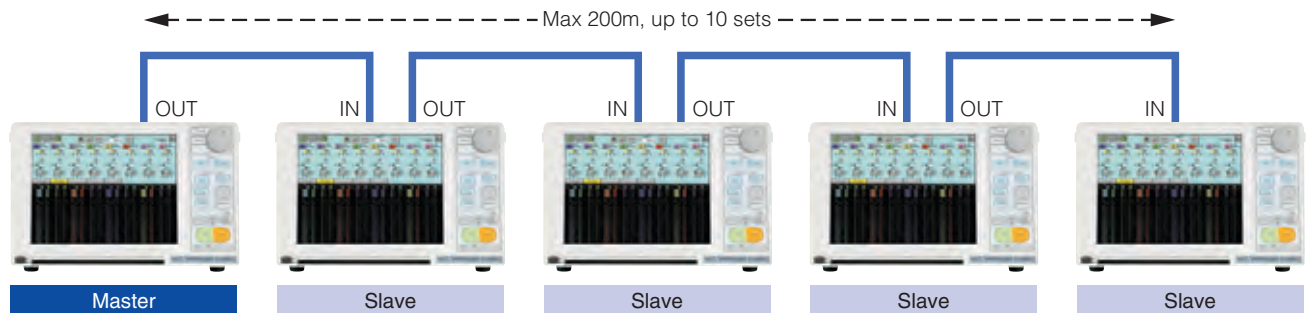

Master memory data sample

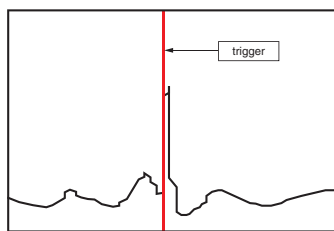

Slave memory data sample

The high speed, multi-channel time synchronized data recorded by the RA2800A master and slave units is also simultaneously triggered. The trigger signal to simultaneously start and end memory recording in all units can be generated by either the master or any slave unit.

The Unifizer Model 3000 series remote control software is recommended for multi-unit synchronization applications.

DIV Sensitivity Unit - Model RA28-112 (Model RA2800A units only)

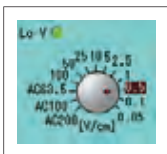

● AC Voltage Level Detector 1540/1543

These external devices detect 100/120V & 220/240V voltage sags & surges exceeding selected 10% or 20% of AC peak value. A Model 1539 AC/DC Multi-Range Voltage Detector (not shown) that detects presence or absence of selected low or high voltages is helpful in determining system timing sequences. All detector outputs are ideal for use with all RA series recorder Event/Logic inputs.



Recording electrical power signals and displaying the results in an electromagnetic oscillograph format is provided using the RA28-112 software. Simply set the recorder V/cm range sensitivity to AC220V/cm, AC100V/cm, or AC63.5V/cm range to display or print a true sine wave AC voltage amplitude at 1cm/p-p per channel.

Input = AC100V; Range = 100V/cm

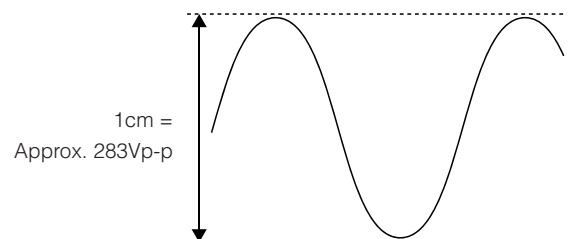

Utility Software for General Data Display and Conversion - Model RA23-701

(Download this software free after completing User Registration)

Use the Model RA23-701 software to enhance PC viewing of data recorded on any RA1000 or RA2000 series Data Acquisition Recorder.

● Display of Data on PC

Display recorder display screen on PC monitor, enlarge time axis, scale x100 to x1/100, search (jump functions: time, address, event, & particular point), and readout of cursor data values.

● File Conversion

Converts recorded data into Binary or CSV file formats.

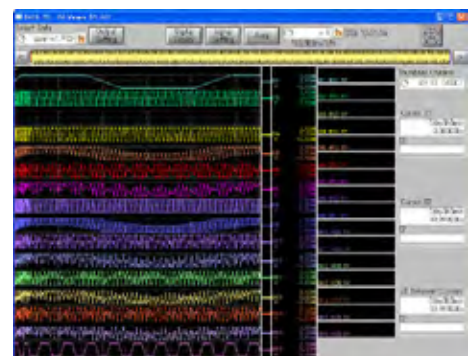

Input Unit Selection Block Diagram

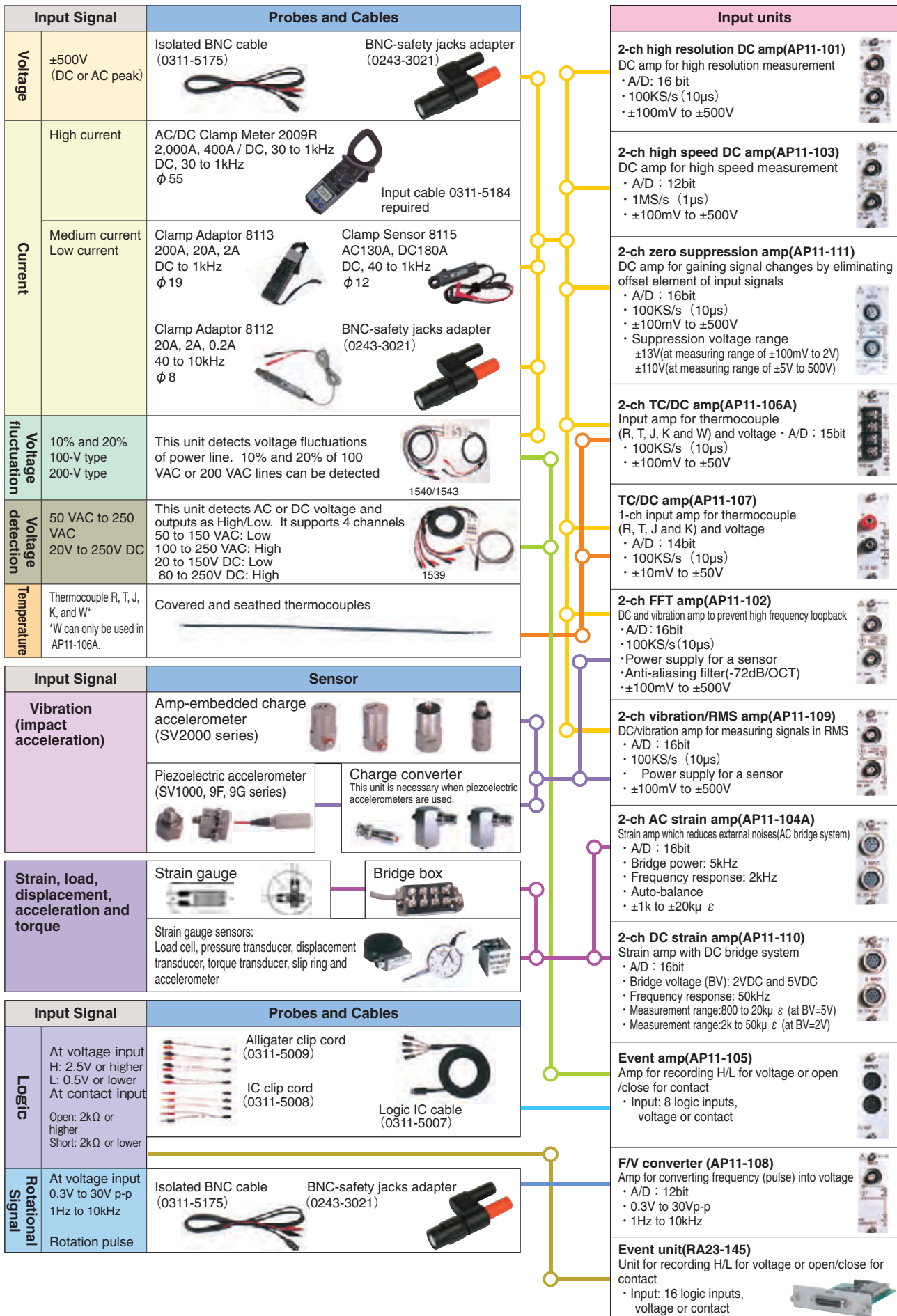

Basic Specifications

■ Basic Specifications

Display	12.1-inch TFT color LCD Effective screen area : 245.76mm x 184.32mm (1024 x 768 pixels)										
Channel	RA2300A : 16ch (8 slots) + digital input 16ch (optional) RA2800A : 32ch (16 slots) + digital input 16ch (Cable is optional)										
Printer	<table border="1"> <tr> <td>Printing Method</td> <td>Thermal printing using a thermal head</td> </tr> <tr> <td>Paper Width</td> <td>219.5mm</td> </tr> <tr> <td>Effective Recording Width</td> <td>1 division (200mm · FS) to 16 division (10mm · FS), number of division and printing width can be changed.</td> </tr> <tr> <td>Channel Discrimination</td> <td>Prints channel number in the vicinity of the printed waveform. The ON/OFF function is available.</td> </tr> <tr> <td>Grid Pattern</td> <td>Standard (10mm, 5mm), 10mm, 5mm, No grid</td> </tr> </table>	Printing Method	Thermal printing using a thermal head	Paper Width	219.5mm	Effective Recording Width	1 division (200mm · FS) to 16 division (10mm · FS), number of division and printing width can be changed.	Channel Discrimination	Prints channel number in the vicinity of the printed waveform. The ON/OFF function is available.	Grid Pattern	Standard (10mm, 5mm), 10mm, 5mm, No grid
Printing Method	Thermal printing using a thermal head										
Paper Width	219.5mm										
Effective Recording Width	1 division (200mm · FS) to 16 division (10mm · FS), number of division and printing width can be changed.										
Channel Discrimination	Prints channel number in the vicinity of the printed waveform. The ON/OFF function is available.										
Grid Pattern	Standard (10mm, 5mm), 10mm, 5mm, No grid										
Battery Backup	RA2300A : Clock, Setting value: approx 3 to 5 years (using a primary battery) RA2800A : Clock, Setting value: approx 3 years (using a primary battery)										
Storage Device	40GB Hard Disk Drive (HDD) , USB memory.										
Interface	Ethernet, USB standard *** Ethernet has basis over CAT5 (shielded) RS-232C, Remote terminal : optional										
Compatible specifications	EMC: EN1326 A1/A2/A3 Safety: EN61010-1										
Operating Environment	Temperature: 5 to 40 °C , Humidity: 35 to 80 %RH (without condensation)										
Power Supply	90 to 264VAC, frequency 50 to 60Hz										
Power Consumption	RA2300A : 100VA (typical) : with AP11-101 x 8 units (approx 300VA max) RA2800A : 170VA (typical) : with AP11-103 x 16 units (approx 350VA max)										
Dimensions	RA2300A : Approx. 369.5(W) x 164.5(H) x 301(D) mm RA2800A : Approx. 400(W) x 270(H) x 380(D) mm										
Weight	RA2300A : 8.0kg or less(main body only), 8.7kg or less(main body with AP-11-103x4 units) RA2800A : 16.4kg or less(main body only), 18.8kg or less(main body with AP-11-103x16 units)										

■ Communication & Storage Specifications

HDD	<table border="1"> <tr> <td>Function</td> <td>Setting conditions of main unit and save/read out of measured data</td> </tr> <tr> <td>Capacity</td> <td>40GB (system domain 5GB + data storage space 35GB)</td> </tr> </table>	Function	Setting conditions of main unit and save/read out of measured data	Capacity	40GB (system domain 5GB + data storage space 35GB)		
Function	Setting conditions of main unit and save/read out of measured data						
Capacity	40GB (system domain 5GB + data storage space 35GB)						
Ethernet	<table border="1"> <tr> <td>Function</td> <td>Control with communication command, Windows and file sharing with Windows PC</td> </tr> <tr> <td>Standard</td> <td>10/100 BASE-T</td> </tr> </table>	Function	Control with communication command, Windows and file sharing with Windows PC	Standard	10/100 BASE-T		
Function	Control with communication command, Windows and file sharing with Windows PC						
Standard	10/100 BASE-T						
USB	<table border="1"> <tr> <td>Function</td> <td>Data saving on storage device by USB connection</td> </tr> <tr> <td>Standard</td> <td>2.0</td> </tr> <tr> <td>Available Storage Device</td> <td>USB memory</td> </tr> </table>	Function	Data saving on storage device by USB connection	Standard	2.0	Available Storage Device	USB memory
Function	Data saving on storage device by USB connection						
Standard	2.0						
Available Storage Device	USB memory						

■ Trigger Specifications

Trigger Mode	OR, AND, WINDOW, OFF								
Trigger Source	Input signal, Manual trigger, External trigger								
Trigger Settings	Amps other than Event Amp Trigger slope : OR, AND ... ↑ or ↓ , WINDOW ... OUT or IN Level setting : To be set with physical values (e.g. voltage) Event Amp (AP11-105), main unit event (option for RA2300A) State setting : H, L, or X can be set for each input. When X is set, trigger condition is not applied. Trigger setting : AND or OR of state setting conditions of inputs from 1 to 8.								
Trigger Related Functions	<table border="1"> <tr> <td>Trigger output</td> <td>Output signal when trigger conditions are met (TTL Low active H over 2V, L below 0.8V, Pulse width : approx 10ms)</td> </tr> <tr> <td>Pre-trigger</td> <td>0 to 100% (1% step)</td> </tr> <tr> <td>Trigger mark</td> <td>Record trigger point with an arrow (↓) and print print year, date and time trigger occurred.</td> </tr> <tr> <td>Trigger filter</td> <td>1 to 65534 samples</td> </tr> </table>	Trigger output	Output signal when trigger conditions are met (TTL Low active H over 2V, L below 0.8V, Pulse width : approx 10ms)	Pre-trigger	0 to 100% (1% step)	Trigger mark	Record trigger point with an arrow (↓) and print print year, date and time trigger occurred.	Trigger filter	1 to 65534 samples
Trigger output	Output signal when trigger conditions are met (TTL Low active H over 2V, L below 0.8V, Pulse width : approx 10ms)								
Pre-trigger	0 to 100% (1% step)								
Trigger mark	Record trigger point with an arrow (↓) and print print year, date and time trigger occurred.								
Trigger filter	1 to 65534 samples								

■ Measuring Mode (Acquisition/Recording) Specifications

Pen Recorder													
Waveform Printing	<table border="1"> <tr> <td>Function</td> <td>Printout input signal data on recording paper (waveform)</td> </tr> <tr> <td>Measurement Starting Operation</td> <td>Start with pressing START key or preset time. Interval recording available.</td> </tr> <tr> <td>Paper-feed Speed</td> <td>RA2300A : 100 mm/s to 1 mm/min (user setting, external synchronization enabled) RA2800A : 50 mm/s to 1 mm/min (user setting, external synchronization enabled)</td> </tr> <tr> <td>Frequency Response</td> <td>DC to 100 kHz (sampling : 10 points/cycle), varies by input units.</td> </tr> <tr> <td>Printing Density</td> <td>Voltage axis : 8 dots/mm, Time axis : 80 dots/mm (at 25 mm/s)</td> </tr> <tr> <td>Printing Length</td> <td>Continuous</td> </tr> </table>	Function	Printout input signal data on recording paper (waveform)	Measurement Starting Operation	Start with pressing START key or preset time. Interval recording available.	Paper-feed Speed	RA2300A : 100 mm/s to 1 mm/min (user setting, external synchronization enabled) RA2800A : 50 mm/s to 1 mm/min (user setting, external synchronization enabled)	Frequency Response	DC to 100 kHz (sampling : 10 points/cycle), varies by input units.	Printing Density	Voltage axis : 8 dots/mm, Time axis : 80 dots/mm (at 25 mm/s)	Printing Length	Continuous
Function	Printout input signal data on recording paper (waveform)												
Measurement Starting Operation	Start with pressing START key or preset time. Interval recording available.												
Paper-feed Speed	RA2300A : 100 mm/s to 1 mm/min (user setting, external synchronization enabled) RA2800A : 50 mm/s to 1 mm/min (user setting, external synchronization enabled)												
Frequency Response	DC to 100 kHz (sampling : 10 points/cycle), varies by input units.												
Printing Density	Voltage axis : 8 dots/mm, Time axis : 80 dots/mm (at 25 mm/s)												
Printing Length	Continuous												
Data Backup	N/A												

HD Recorder

Data Recording	
Function	Real-time recording of measured data on HD (sample of peak style is selectable)
Recordable Size	35GB max
Measurement Starting Operation	Start with pressing START key, trigger detection or preset time.
Sampling Speed	RA2300A : 1µs (w/1ch), 5µs (w/8ch), 10µs (w/16ch) max RA2800A : 2µs (w/1ch), 10µs (w/16ch), 20µs (w/32ch) max
Recording Method	Normal or Ring recording (repeated recording during preset time) selectable.
Waveform Printing (Refer to Pen Recorder spec)	
Function	Printout input signal data on recording paper (waveform)
Measurement Starting Operation	ON/OFF of printout to recording paper while HD recording

Memory Recorder

Data Recording	
Function	Record measured data on memory in main unit.
Measurement Operation	Once, Repeat, or Endless
Memory Capacity	RA2300A : 2MW/ch (w/16ch), 32MW/ch (w/1ch) RA2800A : 1MW/ch (w/32ch), 32MW/ch (w/1ch)
Memory Division	1, 2, 4, 8, 16, 32, 64 or 128 divisions
Sampling Speed	RA2300A : 1µs to 100s (user setting, external synchronization enabled) RA2800A : 2µs to 100s (user setting, Sampling is synchronized with RA28-132)
Waveform Printing	
Function	Printout input signal data on recording paper (waveform)
Printing Density	Voltage axis : 8 dots/mm, Time axis : 10 dots/mm
Copy Magnification	x100 to x1/10,000
Memory Filing	Data is saved on the memory device in binary or CSV format every time when it is stored in memories.
Data Backup	Memory backup with HDD (data saved in a specified area of HDD at shutdown)
Save / Copy Area	Copy with trigger at center : 1 to 100% (1% step), copy between two cursors.

Multi Recorder

Function	Steady-state and transient events can be recorded simultaneously on HD, memory and/or recording paper
Pen Recorder	Refer to Pen Recorder spec
HD Recorder	Refer to HD Recorder spec
Memory Recorder	Refer to Memory Recorder spec (waveform printing available)

■ Measuring Mode (Acquisition/Recording) Specifications

X-Y Recorder	
Function	ON/OFF of locas enabled (pen up & down)
Axis Setting	Input signal monitor, freeze, copy and X-Y display during data recording available. X-axis: 1 channel, Y-axis: 3 channels
Measuring Speed	1ms to 1s
Data recording	
Function	Record all input signals (if input channels is ON at amp setting display) on HD.
X-Y waveform Printing (Printout)	
Function	Printout displayed waveforms (X-axis : 1ch, Y-axis : 3ch) at A4 size
Resolution	1600 x 1600 dots (at printout), 650 x 650 dots (at display)

■ Measured Data Display (Replay Monitor) Specifications

Function	Display recorded data at X-T or X-Y when pressed "Replay" button on operation panel.
Available Measuring Mode	All (irrelevant to actual measuring mode)
Y-T Display	
Waveform Division	1 to 16 divisions
Display Magnification	x 100 to x 1/10,000 (** Peak style is not enlarged)
Thumbnail Function	Display whole data of selected one channel on a thumbnail bar
Numeric Display	Numeric value, cursor value, numeric + cursor values (by switching over)
Search Function	Search by cursor, time, address, max/min and event
X-Y Display	
Channels Allowed	Up to 1ch/X-axis and 3ch/Y-axis can be displayed (to be selected by user)
Data Output	On file and printing paper
Output File Format	Binary or CSV data

■ Output Specifications

Printer	
Data Information	Measuring mode, year/month/day, measurement start time, data No., trigger conditions(trigger point, trigger date, trigger time), sampling speed, paper speed, time axis can be printed with waveforms. ON/OFF selectable.
Channel Information	Print input unit settings when saved. ON/OFF selectable.
Mark Print	Pen-Recorder, HD-Recorder, mark (date/time) print
Screen Copy	Print screen image on recording paper
Line Width for Printing	Select base line boldness for each channel (1, 2, 3, or 4 dots)
Auto Function	
Function	By pressing "Auto" button on an operational panel, sampling speed and input range are auto-configured in reference to input signal.
Auto sample	Display speed, paper feed speed memory sampling speed are auto-configured
Auto range	Range in input amps is auto-configured. (Except for event amp : AP11-105)
Timer Function	Start time, end time and interval can be set.
CSV conversion	Available (also batch conversion of multiple memories or files)
Screen Image Saving	Save screen image on HDD at BMP format (colored)
Monitor output	Images on LCD are output to monitor by XGA (1024 x 768 dots) : RA2800A only
Save/Readout of Settings	Save up to 4 settings (input and main unit settings conditions) on HDD.
Keylock Function	Void key input to prevent operational error (password protected)
Physical Value Conversion	Physical conversion of input signals, full scale change on display, registration of units.
Waveform Display of Event Input	Display position of event amp (AP11-105) and main unit (option for RA2300A) is movable. (every 8ch, standard position and pitch are configurable. In case of RA2800A with event amps, 8 units are available for display and recording at the same time. (16 units are available for data recording)

■ Optional Unit

AC Bridge Power Supply Unit (RA23-143)	
Function	Bridge power source for 2-ch AC strain amp
Power Voltage, Carrier Wave	2Vrms, sine wave 5kHz
Synchronization	Synchronization with other RA2300s using built-in AC bridge power units is available.
Weight	60g or less

RS-232C Unit (RA23-142)

Standard	JIS X5101 (former C6361) complied
Transfer speed	38400, 19200, 9600, 4800 or 2400bps
Connector	D-sub 9-pin connector
Function	
Shutdown	Shutdown operation when using UPS
Remote Control	Remote Control from PC via RS-232C cable
Weight	50g or less

Remote Unit (RA23-144)

Function	Start, Stop, Mark print, Paper feed is possible by the external signal. Input synchronization pulse. Output error signal. Input UPS protect signal.
Cables	1.5m, I/O connector 28-pin and open wire.
Weight	65g or less

Event Unit (RA23-145) *, Event Unit A (RA23-145A) : RA2300A Only

Function	Input logic signal directly into main unit (independent from other amps)
Number of signals	16
Input Signals	Voltage input : input voltage range 0 to +5 V
Signal level	H : over 2.0V, L : below 0.8V
Cables	RA23-145 : Event Input Cable (0311-5252) RA23-145A : Event Input Extension Cable (RA23-127)
Weight	60g or less

Event BOX Set (RA23-146) : RA2300A Only

Function	Input logic signal directly into main unit (independent from other amps)
Number of signals	16
Input Type	Common ground in unit, case-free
Input Signals	Sets voltage or contact for each channel Voltage input : input voltage range 0 to +2.4 V Detection level : H level 2.5V or higher L level 0.5V or higher
Response Time	Contact input : open 2k Ω or higher, close 250 Ω or lower
Input Connector	Within 1µs (at input "H", level +5V or higher) Circular DIN connector 8P x 4, Event Amp Unit side : XT2B-0800 (conformity with DIN45326)

*1 Event unit (RA23-145, RA23-145A)

The difference of unit style is only standard cables(0311-5252 or RA23-127) . Units have same specifications. Regardless of styles, (RA23-145) is printed on units.

Option Unit Arithmetic FFT Unit (RA23-751)

Object data	Internal memory data, filing data (extension : DRT, FSD) ※ except for peak style (extension : FPP, IDX)
Interval statistical calculation	
Calculation	max, min, P-P value, average, square, actual value, standard deviation, rising time, trailing time
Out put file format	CSV data
Functional calculation	
Calculation	four arithmetic operations (+, -, x, /), absolute value, first derivation, second derivation, first integration, second integration, square root, index, common logarithm, moving average, trigonometric function (sin, cos, tan, asin, acos, atan)
Out put file format	Binary or CSV data
FFT Analysis	
Function	One signal analysis : linear spectrum, Power spectrum, RMS spectrum, power histogram density, octave analysis (1/1, 1/3) Two signal analysis : transfer function, cross power spectrum, coherence function
Analyzed data length	1000 (400), 2000 (800), 4000 (1600)
Window function	rectangular, hanning, hamming
Out put file format	Binary or CSV data

Unifizer NS3100(online function, offline function)

OS	Windows 2000 / XP / Vista Ultimate
Available system	RA2000 series / RA1000 series / others
Interface	RA2000 series : Ethernet RA1000 series : RS-232C / Ethernet
Connectable quantity	MAX 8 sets(RA2000series/RA1000series/others mixable)
Remote control	Pen recorder mode/HD recorder mode/Memory recorder mode/Multi recorder mode(RA2000 series) Memory mode/Real time mode/Transit mode/Filing mode(RA1000 series)
Setting range of transfer speed	RA series : 1ms ~ 1000ms(1msSTEP), 1s ~ 1000s(1sSTEP) ¹ Max recordable time: up to the half size of specified HD in PC ** It may not transfer in set speed depending on CPU speed. Recommended CPU : over 2GHz Recommended memory capacity : over 512MB*
Real time data display function	Y-T waveform, X-Y waveform(split/overwriting), Digital display ²
Play data display function	Y-T waveform, X-Y waveform(split/overwriting), Digital display Data of RA2000 series/ RA1000 series is playable Playable extension: FSD, FPP, DRT, DAT*
Cursor readout of playing data	Readout value between cursor 1 and 2, time difference, amplitude difference, max/min value between cursors
Arithmetic operation	Arithmetic operation between channels, Power method, Square root, Absolute value, Customary logarithm, Index, actual value, Trigonometric function, Moving average, Derivation, Integration, Below functions are combined together _ Sine, Cosine, Tangent, Arcsine, Arccosine, Arctangent, Absolute value, Index, Logarithm natural, Customary logarithm, Square root, Cube root, Arithmetic operation CH specification, Power method, First-order derivation, Second-order derivation, First-order integration, Second-order integration, Saved data reference 1, Saved data reference 2, Moving average
File conversion	Conversion into CSV file following condition can be set • Specification of conversion area point, of period(μs, ms, sec), of time • Conversion channel • Break character _ comma(,), TAB • Thinning out, simple, max/min value, average value, peak value • Adding of header information • Saved file name
Saving and reading of recorded file condition	Available for arbitrary files

The detail is listed in Unifizer NS3000 series catalogue.

Sensitive DIV unit (RA28-112) : Application for measuring electricity : RA2800A only

Amplifier	High resolution DC amplifier : AP11-101 FFT amplifier : AP11-102 (V measuring mode) High speed DC amplifier : AP11-103/Vibration RMS amplifier : AP11-109 (V measuring mode) Zero suppression amplifier : AP11-111
Sensitivity display	AC200V/cm, AC100V/cm, AC63.5/cm, 100V/cm, 50V/cm, 25V/cm, 10V/cm, 5V/cm, 2.5V/cm, 1V/cm, 0.5V/cm : Max input voltage ±500V 0.1V/cm, 0.05V/cm: Max input voltage ±100V
Amplitude adjustment	All range _ fine adjustment of recording amplitude AC range _ fine adjustment in AC range
Waveform recording	Waveform division 1/1 fixed (1 scale is 1cm on recording papers)
Grid	10mm standard, 10mm, 10mm longitudinal, OFF switch, (NO 5mm grid) 1cm x 1cm grid printing by default
Scale print	Print of sensitivity information (no scale value)
Trigger mark	Print of trigger time, ON/OFF function (pointer is printed at any time)
Speed display	s/div range display (Pen recorder, Memory recorder, HD recorder)

Synchronous unit (RA28-132) : RA2800A only

Max synchronous units	Total 10 sets
Connector / cable length	Synchronous connector : RJ45 compliance Connection cable: Litz wire STP(Shield Twist Pair), Straight connection wire (CAT5e or CAT6 compliance) Cable length : max 200m
Setting	Selection of synchronous mode Master/ Slave / External synchronization
Delay time (including connected units to whole connection cable length and trigger detection delay time)	
8μs	Within 200m : 2 units / 100m : 3 units / 33m : 4 units
10μs	Within 200m : 3 units / 100m : 5 units / 33m : 7 units
20μs	Within 200m : 5 units / 100m : 7 units / 33m : 10 units
50μs	Within 200m : 10 units

Utility software RA Viewer (RA23-701)

OS	Windows2000/XP , display 1024 x 768 and above
Available system	RA2000 series / RA1000 series
Y-T display	
Peace wise representation	1 ~ 16 split
Display magnification	x100 ~ x10,000
Thumbnail function	Optional 1ch of whole data is available for display on thumbnail bar
Value display	Value, cursor value, value + cursor value (switching)
Search function	Search by cursor, time, address, max/min, event
X-Y display	
Display channel number	Selected data can be displayed on x-axis:1ch, y-axis:3ch
Out put file format	Binary or CSV data
Download	This software is available for download after completion of user registration

*1: Setting speed may not work due to constraint of main unit or CPU speed in PC.

*2: Real time monitor is not displayed for RA1000 series.

Input Unit Specifications

2-CH High Resolution Amp(AP11-101) & 2-CH High Speed Amp(AP11-103)

Input	2 chs/unit, isolated unbalanced input, isolated BNC connector
Input Coupling	AC and DC coupling
Input Impedance	1M Ω or higher
Measurement Range	±0.1, 0.2, 0.5, 1, 2, 5, 10, 20, 50, 100, 200, 500V FS
Range Accuracy	AP11-101: within ±0.3% FS(within ±0.8% FS at ±500V) AP11-103: within ±0.5% FS(within ±0.8% FS at ±500V)
Offset Accuracy	AP11-101: within ±0.3% FS(at 25°C) AP11-103: within ±0.5% FS
Linearity	AP11-101: within ±0.1% FS(at 25°C) AP11-103: within ±0.2% FS
Allowable Input Voltage	Range of ±10V to 500V: ±500V max(DC or AC peak values) Range of ±0.1V to 5V: ±100V max(DC or AC peak values)
CMV	Unit only: 42V (DC or AC peak values) When using isolated BNC cable(optional): 300VAC
Frequency Response	AP11-101/at DC coupling: DC to 50kHz(+0.5, -3dB) at AC coupling: 0.3 to 50kHz(+0.5, -3dB) AP11-103/at DC coupling: DC to 400kHz(+0.5, -3dB) at AC coupling: 0.3 to 400kHz(+0.5, -3dB)
Low-pass Filter	AP11-101/bessel type(attenuation factor: -12dB/OCT) 30, 300, 3kHz, OFF(+0.5, -3dB) AP11-103/bessel type(attenuation factor: -12dB/OCT) 5, 50, 500, 5k, 50kHz, OFF(+0.5, -3dB)
A/D Converter	AP11-101: 16-bit, 100kHz max(simultaneous 2-ch sampling) AP11-103: 12-bit, 1MHz max(simultaneous 2-ch sampling)
Temperature Stability	AP11-101/zero point: within ±0.02% FS/°C AP11-103/zero point: within ±0.03% FS/°C
Gain(Range)	within ±0.01% FS/°C
Weight	AP11-101: approx 230g or less, AP11-103: approx 240g or less

F/V Converter(AP11-108)

Input	1 ch/unit, isolated unbalanced input, BNC connector
Input Coupling	AC and DC coupling
Input Impedance	100k Ω or higher
Input Frequency Range	1Hz to 10kHz(pulse width: 20 μs or longer)
Measurement Range	0.1, 0.2, 0.5, 1, 2, 5, 10kHz FS
Accuracy	Within ±0.5% FS
Linearity	Within ±0.3% FS
Trigger Level	Selectable from 0V or 2.5V
Allowable Input Voltage	± 100V (DC or AC peak values)
CMV	Unit only: 42V (DC or AC peak values), when using isolated BNC cable (optional): 300VAC
Response Time	Approx 20ms(at the range of 10kHz)
A/D Converter	16-bit, 100kHz max
Temperature Stability	Zero point: within ±0.03% FS/°C Gain(range): within ±0.02% FS/°C
Weight	125g or less

2-CH Vibration/RMS Amp(AP11-109)

Input	2 chs/unit, isolated unbalanced input, isolated BNC connector
Input Coupling	AC and DC coupling
Input Impedance	1M Ω or higher
Power Supply for Sensor	2mA, 18V or higher
Measurement Range	0.1, 0.2, 0.5, 1, 2, 5, 10, 20, 50, 100, 200, 500V
Accuracy	Voltage Within ±0.3% FS(within ±0.8% FS at ±500V) RMS Within ±2% FS(at DC and 40Hz to 20kHz)
Linearity	within ±0.1% FS
Crest Factor	2.8 max(when used as RMS amp)
CMV	Unit only: 42V (DC or AC peak values) When using isolated BNC cable(optional): 300VAC
Frequency Response	DC coupling: DC to 50kHz(+1, -3dB) AC coupling: 1 to 50kHz(+1, -3dB)
Low-pass Filter	Butterworth type(attenuation factor: -24dB/OCT) 30, 100, 300Hz, 1kHz and OFF
High-pass Filter	Butterworth type(attenuation factor: -24dB/OCT) 10, 30, 100Hz and OFF
A/D Converter	16-bit, 100kHz max
Temperature Stability	Zero point: within ±0.02% FS/°C Gain(range): within ±0.01% FS/°C
Weight	270g or less

2-CH FFT Amp(AP11-102)

Input	2 chs/unit, isolated unbalanced input, isolated BNC connector
Input Coupling	AC and DC coupling(only AC coupling when connected with amp-embedded piezoelectric accelerometer)
Input Impedance	1M Ω or higher
Power Supply for Sensor	2mA, +18V or higher
Measurement Range	±0.1, 0.2, 0.5, 1, 2, 5, 10, 20, 50, 100, 200, 500V FS
Range Accuracy	Within ±0.3% FS(within ±0.8% FS at ±500V)
Linearity	within ±0.1% FS
Allowable Input Voltage	±500V (DC or AC peak values) (±30V at AC coupling in ±0.1 to 5V range)
CMV	Unit only: 42V (DC or AC peak values) When using isolated BNC cable(optional): 300VAC
Frequency Response	DC coupling: DC to 50kHz(+0.5, -3dB) AC coupling: 0.3 to 50kHz(+0.5, -3dB)
Low-pass Filter	Bessel type(attenuation factor: -12dB/OCT) 30, 300, 3kHz, OFF(+0.5, -3dB)
Anti-aliasing Filter	20, 40, 80, 200, 400, 800Hz; 2, 4, 8, 20, 40kHz
Drop characteristics	-72dB/OCT at 1.5 x fc
Offset Accuracy	within ±0.3% FS(at 25°C)
A/D Converter	16-bit, 100kHz max
Temperature Stability	Zero point: within ±0.02% FS/°C Gain(range): within ±0.01% FS/°C
Weight	240g or less

2-CH TC/DC Amp(AP11-106A) & TC/DC Amp(AP11-107)

Input	AP11-106A: 2 chs/unit, isolated unbalanced input, terminal block M4 AP11-107: 1 ch/unit, isolated unbalanced input, 2 binding posts		
Input Coupling	DC coupling		
Input Impedance	10M Ω or higher(approx 1M Ω at 5, 10, 20, 50VFS in DC range)		
Thermocouple	AP11-106A: R, T, J, K, W AP11-107: R, T, J, K		
Measurement Range(Temperature)	AP11-106A	AP11-107	
	R:	1760°C FS(0 to 1760°C)	800°C FS(0 to 800°C) , 1600°C FS(0 to 1600°C)
	T:	400°C FS(-200 to 400°C)	200°C FS(-200 to 200°C) , 400°C FS(-200 to 400°C)
	J:	1100°C FS(-200 to 1100°C)	200°C FS(-200 to 200°C) , 1000°C FS(-200 to 1000°C)
	K:	300°C FS(-200 to 300°C) , 1370°C FS(-200 to 1370°C)	200°C FS(-200 to 200°C) , 1200°C FS(-200 to 1200°C)
W:	2300°C FS(0 to 2300°C)	N/A	
Measurement Range(Voltage)	AP11-106A: 100, 200, 500mV, 1, 2, 5, 10, 20, 50V FS AP11-107: 10, 20, 50, 100, 200, 500mV, 1, 2, 5, 10, 20, 50V FS		
	Temperature: ±0.5% FS(within ±1% at 0°C or lower)		
Range Accuracy	±0.3% FS(AP11-106A) , ±0.5% FS(AP11-109)		
Cold Junction Compensation	Internal/external switchable. Accuracy: within ±2°C (within ±1°C at stable temperature of 20°C at input terminal)		
Linearity	Within ±0.1% FS		
Allowable Input Voltage	50V (DC or AC peak values)		
CMV	AP11-106A:	42V(DC or AC peak values)	
	AP11-107:	300V(DC or AC peak values)	
Frequency Response	DC to 40kHz(+0.5, -3dB)		
Low-pass Filter	Bessel type(attenuation factor: -18dB/OCT) 1, 30, 500, 5kHz, OFF(+0.5, -3dB)		
A/D Converter	AP11-106A: 15-bit, 100kHz max(simultaneous 2-ch sampling) AP11-107: 14-bit, 100kHz max		
Temperature Stability	When used as temp amp(gain(range): within ±0.04% FS/°C When used as DC amp/zero point: within ±0.03% FS/°C gain(range): within ±0.01% FS/°C		
	Weight		
AP11-106A: 240g or less, AP11-107: 200g or less			

Event Amp(AP11-105)

Input	8 channels/unit
Input Type	Common ground in unit, case-free
Input Signals	Sets voltage or contact for each channel
	Voltage input: input voltage range 0 to +24V detection level: H level 2.5V or higher L level 0.5V or lower
Response Time	Contact input: open 2k Ω or higher, close 250 Ω or lower Within 1µs (at input 'H', level +5V or higher)
Cables	Logic IC cord(0311-5007) x 2; alligator clip cord(0311-5009) x 2 IC clip cord(0311-5008) x 2
Weight	100g or less

Charge Converter(AP11-901, AP11-902, AP11-903)

Gain	1.0mV/pC±5%(AP11-901, AP11-902), 0.1mV/pC±5%(AP11-903)
Max Input Charge	5000pC(AP11-901, AP11-902), 50000pC(AP11-903)
Frequency Range	Approx 1.6Hz to 50Hz
Max Output Voltage	5Vp-p or lower
Drive Voltage	12 to 25 VDC
Drive Current	0.5 to 5mA
Rated Noise	20µVrms or lower(AP11-902), 100µVrms or lower(AP11-901, AP11-903)
Phase	180°
Operating Temperature	-20 to 80°C (AP11-901), -20 to 110°C (AP11-902, AP11-903)
Connector	Input: miniature connector(10-32UNF) Output: male BNC terminal(AP11-901) female BNC connector(AP11-902, AP11-903)
Weight	20g or less(AP11-901), 65g or less(AP11-902, AP11-903)

2-CH AC Strain Amp(AP11-104A) & 2-CH DC Strain Amp(AP11-110)

Input	2 chs/unit, isolated unbalanced input, isolated NDIS connector	
Input Coupling	AP11-104A: balanced input(isolation: between channels inside unit or between each channel and chassis) AP11-110: DC	
Input Impedance	10M Ω + 10M Ω or higher (AP11-110 only)	
Bridge Power Supply	AP11-104A: sine wave 2Vrms, 5kHz(AC bridge power supply RA23-143 required) AP11-110: 2V, 5V	
Applicable Gauge	AP11-104A: 120 to 1k Ω	
Resistance	AP11-110: 120 to 2k Ω (at BV=2V), 350 to 2k Ω (at BV=5V)	
Gauge Factor	AP11-104A: 1.9 to 2.2 AP11-110: 2.0	
Range of Balance	AP11-104A/resistance: ±2%(10000µ ε) or lower capacitance: 200pF or lower AP11-110/±3%(15000x10-6µ ε) or lower	
	Balance Method	AP11-104A AP11-110
Resistance	Auto-balance	Auto-balance
	Capacitance	Auto-balance(500pF or lower eliminated)
	Balance Time	Within 1s at 1 channel
	Remained Voltage Accuracy	Within ±0.5% FS
Max Sensitivity(AP11-104)	Over full scale at 500µ ε (at bridge voltage of 2V or higher)	
Measurement Range	AP11-104A	AP11-110
	Strain	1k,2k,5k,10k,20kµ ε -FS
Voltage	N/A	2, 5, 10, 20, 50mV FS
Accuracy	Within 0.3% FS(AP11-110 only)	
Internal Calibrator and Accuracy	±0.5k, 1k, 2k, 3k, 5kµ ε Accuracy: within ±0.5% FS (AP11-104 only)	
Linearity	AP11-104A: ±0.2% FS AP11-110: ±0.1% FS	
CMV	300VAC	
Allowable Input Voltage	±8V(DC or AC peak value)	
Frequency Response	AP11-104A: DC to 2kHz(+1, -3dB) AP11-110: DC to 50kHz(+0.5, -3dB)	
Low-pass Filter	AP11-104A: butterworth type(attenuation factor: -12dB/OCT) 10, 30, 100, 300Hz and OFF(+1, -3dB) AP11-110: bessel type(attenuation factor: -12dB/OCT) 10, 30, 100, 300Hz and OFF(+1, -3dB)	
A/D Converter	16 bits, 100kHz max	
Temperature Stability	Zero point: within ±0.05% FS/°C (AP11-104A), within ±0.1% FS/°C (AP11-110) Gain(range): within ±0.05% FS/°C (AP11-104A), within ±0.01% FS/°C (AP11-110)	
Weight	285g or less(AP11-104A), 240g or less(AP11-110)	

2-CH Zero Suppression Amp(AP11-111)

Input	2 chs/unit, isolated unbalanced input, isolated BNC connector
Input Coupling	AC and DC coupling(max allowable input ±30V at AC coupling for measurement range ±0.1 to 2V)
Input Impedance	1M Ω or higher
Measurement Range	±0.1, 0.2, 0.5, 1, 2, 5, 10, 20, 50, 100, 200, 500V FS
Range Accuracy	Within ±0.5% FS(within ±1.0% FS at ±500V FS)
Offset Accuracy	within ±0.5% FS
Linearity	within ±0.2% FS
Allowable Input Voltage	range of ±5V to ±500V: ±500V max(DC or AC peak value) range of ±0.1V to ±2V: ±100V max(DC or AC peak value)
CMV	42V (DC or AC peak values) When using isolated BNC cable(optional): 300VAC
Frequency Response	At DC coupling: DC to 5kHz(+0.5, -3dB) At AC coupling: 0.3 to 5kHz(+0.5, -3dB)
Low-pass Filter	Bessel type(attenuation factor: -12dB/OCT) 30, 30k, 300Hz, OFF(+0.5, -3dB)
Suppression Voltage	±13V at ±0.1, 0.2, 0.5, 1 and 2V range ±110V at ±5, 10, 20, 50, 100, 200, 500V range
	Resolution: 500µV or less at ±0.1, 0.2, 0.5, 1 and 2V range 5mV or less at ±5, 10, 20, 50, 100, 200, 500V range Accuracy: within ±0.5%(at suppression voltage +13V max) Temp Stability: ±0.005%/°C (at suppression voltage +13V max)
Auto Zero Suppression	Recognize current input voltage and suppress the voltage automatically. Time: within 1 sec Remain voltage: within ±(resolution of suppression voltage x 10)V
A/D Converter	16-bit, 100kHz max(simultaneous sampling of 2chs)
Temperature Stability	Zero point: within ±0.03% FS/°C Gain(range): within ±0.01% FS/°C
Weight	260g or less

Main Unit & Accessories

Main Unit*	Item	Model	Standard accessories
	Omniace III		RA2300A
		RA2800A	AC power cable(w/adaptor) x 1, recording paper x 1, paper holder x 1, input unit slot cover plate x 1set and user's manual x 1

*1 Input units are not included.

Input Unit	Item	Model	Rating
		2-ch High Resolution DC Amp	AP11-101
	2-ch High Speed DC Amp	AP11-103	Input: ±100mV to ±500V, A/D resolution: 12-bit, sampling:1µs (RA2800A : 2µs)
	2-ch Zero Suppression Amp	AP11-111	Input: ±100mV to ±500V, A/D resolution: 16-bit, sampling:10µs
	2-ch FFT Amp	AP11-102	Anti-aliasing filter: 72dB/OCT, with power supply for sensor
	Event Amp	AP11-105	Input: 8 logics (voltage/contact)
	2-ch TC/DC Amp	AP11-106A	Input: R, T, J, K, W (±100mV to ±50V), A/D resolution: 15-bit
	TC/DC Amp	AP11-107	Input: R, T, J, K (±10mV to ±50V), A/D resolution: 14-bit
	2-ch AC Strain Amp*2	AP11-104A	Frequency response: 2kHz, bridge power supply: 5kHz
	2-ch DC Strain Amp	AP11-110	Input: 800µ ε to 20k µ ε (BV=5V), 2kµ ε to 50k µ ε (BV=2V),
	2-ch Vibration/RMS Amp	AP11-109	Input: ±100mV to ±500V, sampling:10µs, with power supply for sensor
	F/V converter	AP11-108	Input: 1 Hz to 10k Hz

*2 Optional AC bridge power unit(RA23-143) required.

	Item	Model	Rating	
Optional Unit	Arithmetic FFT Unit	RA23-751		
	Sensitivity DIV setting Unit	RA28-112	RA2800A only	
	Synchronous Unit	RA28-132	RA2800A only	
	Interface	RA23-144	W/cable(1.5m,I/O connector 28-pin and open wire)	
		Remote Unit	RA23-142	
		RS-232C Unit	RA23-142	
	AC Bridge Power Supply Unit	RA23-143		
	Dust Cover	RA11-121	RA2300A only	
		RA28-114	RA2800A only	
	Touch Panel Sheet	RA23-125	RA2300A only, 3 pieces/Set	
	Display Cover	RA23-126		
	Display Protection Board	RA23-131	RA2300A only	
		Event Unit	RA23-145	RA2300A only, W/Cable(0311-5252)
		Event Unit A	RA23-145A	RA2300A only
		Event Input Extension Cable	RA23-127	RA2300A only
		Event Input Cable	0311-5252	RA2300A only
		Event Box _Set	RA23-146	RA2300A only
		Event Box	RA23-316	RA2300A only
		Connecting Cable for Event Box and I/F	0311-5257	RA2300A only
		Event Box Interface	RA23-314	RA2300A only
	Hand Writing Table	RA23-128	RA2300A only	
	Hard Carring Case (w/Casters)	RA11-117	RA2300A only	
		RA28-113	RA2800A only	
	Soft Carryig Case	RT36-115	RA2300A only	
	Roll Paper Take-up	RT31-164	RA2300A only	
		RA28-119	RA2800A only	
	Z-fold Paper Storage Box	RT12-103	RA2300A only, Including Z-fold paper adaptor (RA12-301)	
		RA28-115	RA2800A only, Including Z-fold paper adaptor (RT34-312)	
	Z-fold paper adaptor	RA12-301	RA2300A only	
		7191-5010	RA2800A only	
	Mobile Cart	RA11-118	RA2300A only	
		RA28-116	RA2800A only	
	Rack Mount Bracket for EIJ	RA28-118	RA2800A only	
	Charge Converter ¹	AP11-901	1.0mV/pC, small type(connected to input amp),connectors(input:miniature connector,output:BNC male)	
		AP11-902	1.0mV/pC,connectors(input:miniature connector, output:BNC female)	
		AP11-903	0.1mV/pC,for high sensitivity sensors connectors(input:miniature connector, output:BNC female)	
	AC/DC Voltage Detector	1539	4 inputs	
	AC Voltage Level Detector	1540	1 input, 100VAC / 120VAC	
		1543	1 input, 220VAC / 240VAC	
	Voltage Output Cable	0311-5004	Length: 1.5m, connectors : pin tip and banana plug	
	Voltage Output Extension Cable	0311-5006	Length: 1.4m, connectors : pin tip and pin tip jack	
	AC/DC Digital Clamp Meter	2009R ²	for high current (2000A, 400A / DC and 30 to 1kHz)	
	AC/DC Digital Clamp Adaptor	8113 ³	for medium current (200A, 20A, 2A / DC to 1kHz)	
	Clamp Adaptor	8112 ³	for low current (20A, 2A, 0.2A / 40 to 10kHz)	
	AC/DC Clamp Sensor	8115 ³	for low current (AC / 130A, DC / 180A / DC, 40 to 1kHz)	
Signal Input Cable (for Clamp Meter 2003A output)	0311-5184 ⁴	Length: 2m, small plug for microphone and isolated BNC		
Uninterruptible Power Supply system	SUA500JB ⁵	Smart-UPS500		
UPS cable	0311-5256 ⁵	Length: 2.5m		

¹ Required for using piezoelectric accelerometer with 2-ch vibration/RMS amp or 2-ch FFT amp.

² Use signal input cable(0311-5184) if connecting output from 2009R to RA2300A/RA2800A

³ Use a BNC adaptor(0243-3021) if connecting output from 8112, 8113 and 8115 to RA2300A/RA2800A

⁴ Cable for inputting output from 2009R to isolated BNC connector of RA2300A/RA2800A

⁵ Required for RS-232C Unit (RA23-142), Uninterruptible Power Supply system (SUA500JB), UPS cable(0311-5256) to use auto shutdown function.

	Item	Model	Rating
Cable	Signal Input cable	0311-5175	Length: 2m, isolated BNC connector and alligator clip (+:red, -:black)
		0311-5200	Length: 2m, isolated BNC connector and metal BNC connector
		0311-5177	Length: 2m, safety-BNC connector and open wire
		0311-5160 ⁶	Length: 2m, 2-banana and alligator clip (+:red, -:black)
		0311-5174 ⁶	Length: 2m, 2-banana and BNC connector
	AC bridge power distribution cable	0311-2057	Length: 2m, BNC connector and alligator clip (+:red, -:black), mold color: black
		0311-5084	Length: 2m, BNC connector and alligator clip (+:red, -:black), mold color: red
		47226	Length: 2m, BNC connector and BNC connector
	Logic IC cable	0311-5007	Logic IC cord (1pc)
		0311-5008	IC clip cord(4pcs/set)
		0311-5009	alligator clip cord(4pcs/set)
	Event input cable	0311-5001	Length: 1.5m, DIN8P and open wire
	Event input extension cable	0311-5005	Length: 1.5m, DIN8P plug and DIN8P socket
	BNC Adaptor	0243-3021	Isolated BNC connector and S terminal plug
	BNC Adaptor (for AC bridge power distribution)	0243-2118	T-type Plug / 2receptacles coupler
AC power cable	47326	Length: 2.5m with adaptor	

⁶ BNC adaptor(0243-3021) required if connecting to input unit with isolated BNC terminal.

	Item	Model	Rating
Recording paper ⁷	Recording paper	YPS106	220x30m roll paper(5 rolls/box)
	Recording paper (w/perforated line)	YPS108	220x30m roll paper(5 rolls/box)
	Recording paper (100m roll paper)	YPS114	RA2800A only, 220x100m roll paper(1roll/box)
	Recording paper (Z-fold paper)	YPS112	220x201m Z-fold paper(1 set/box)

⁷ Quality not assured if used papers other than above.

	Item	Model	Rating
Software	Unifizer basic PKG	NS3100-P01	RA2000series, remote control PKG
	Unifizer basic PKG	NS3200-P01	RA series, off line data display PKG
	Unifizer basic PKG2	NS3100-P02	RA1000series, remote control PKG
	Unifizer basic PKG3	NS3100-P03	RA1000/RA2000series, remote control PKG
	Unifizer extension PKG1	NS3100-P04	NS3100-P01+RA1000, driver addition PKG
	Unifizer courtesy PKG ⁸	NS3100-C01	RA2000series, remote control PKG
	Unifizer courtesy PKG ⁸	NS3200-C01	RA series, off line data display PKG
	Unifizer courtesy PKG2 ⁸	NS3100-C02	RA1000series, remote control PKG
Unifizer courtesy PKG3 ⁸	NS3100-C03	RA1000/RA2000series, remote control PKG	

⁸ Unifizer courtesy PKG is only for the owner of Omni viewer (NS2100) .

External Drawing

■ Dimensions of RA2300A

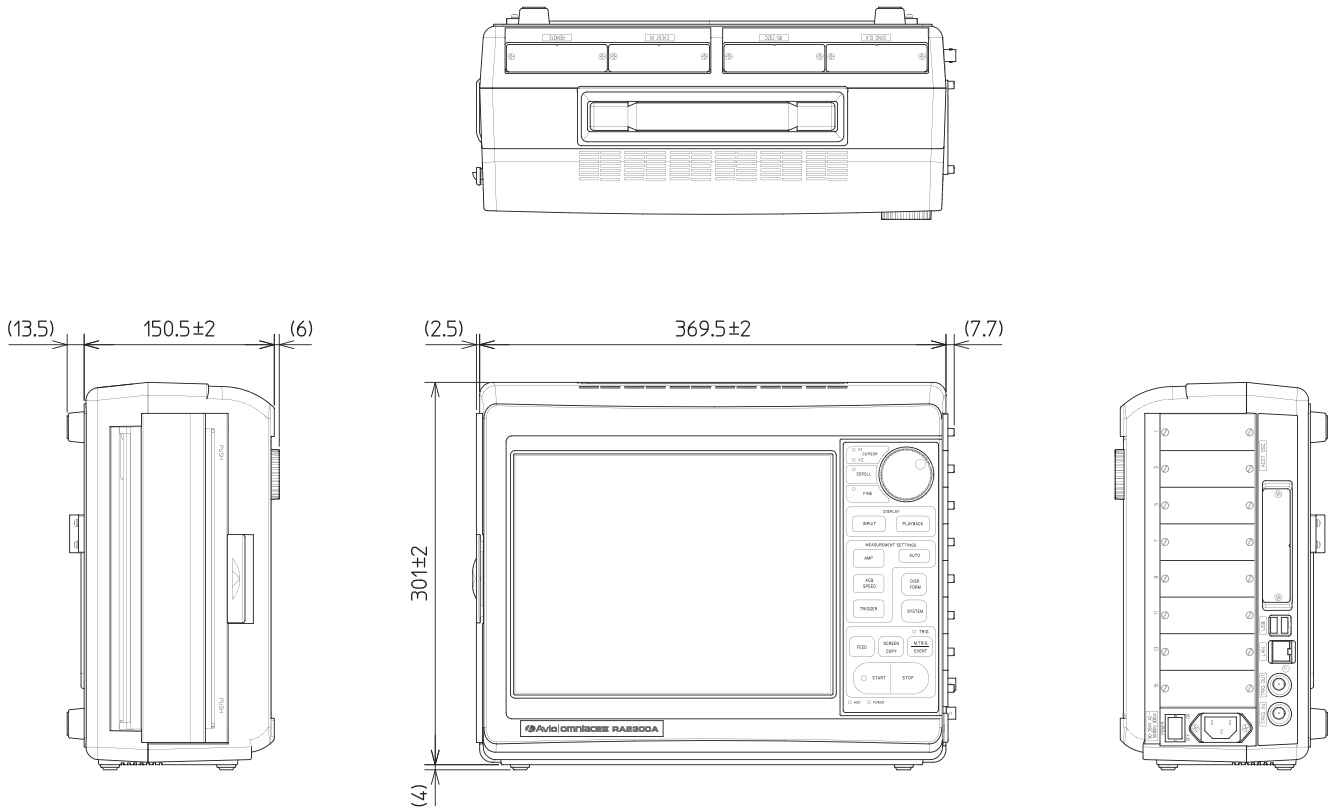

■ Dimensions of RA2800A

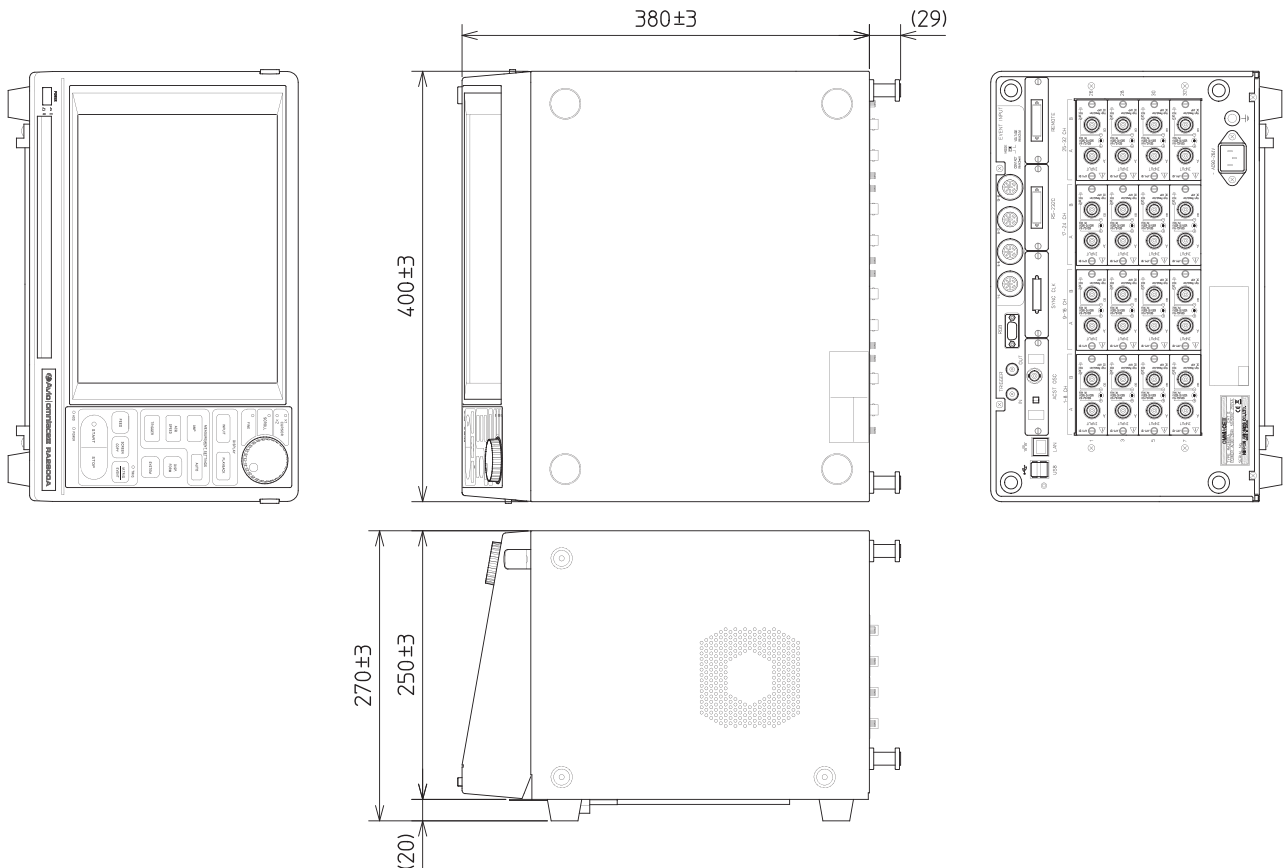

Option Unit Appearance



RA2800A Only



RA2300A Only



RA2300A Only

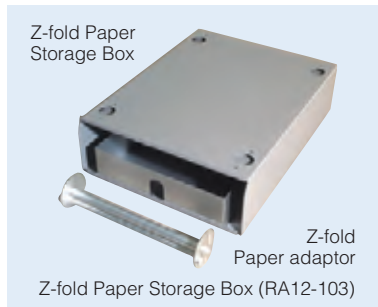

RA2800A Only

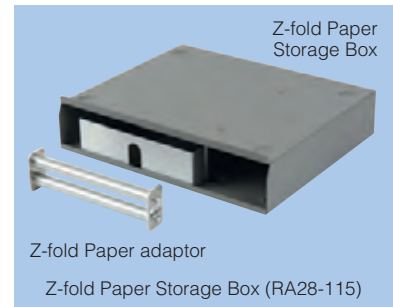

RA2300A Only



RA2300A Only



RA2800A Only



RA2300A Only



RA2300A Only



RA2300A Only



 **NIPPON AVIONICS CO., LTD.**

Infrared & Measuring Equipment Division
1-5, Nishi-Gotanda 8-chome, Shinagawa-ku,
Tokyo 141-0031 Japan
Phone : +81-3-5436-1614
Fax : +81-3-5436-1395
E-mail : product-irc-e@avio.co.jp

<http://www.avio.co.jp/english/>



WARNINGS & CAUTIONS

- Before using this product, please carefully read the provided Operation Manual "WARNINGS" & "CAUTIONS" section to ensure proper operation.
- Please do not place the product in high temperature, high humidity or high inert gas environments.

Distributor:

 **ALAVA
INGENIEROS**

Edificio Antalia
Albasanz, 16
28037 MADRID
Tel.91 567 97 00
Fax:91 570 26 61

www.alavaingenieros.com

Torre Mapfre-Vila Olimpica
Marina, 16 - Planta 11-C2
08005 BARCELONA
Tel.93 459 42 50
Fax:93 459 42 62

alava@alava-ing.es