



UNDERSTANDING, ACCELERATED



TSI PARTICLE TECHNOLOGY

PARTICLE INSTRUMENTS

TSI PARTICLE TECHNOLOGY

TSI Incorporated is a leading developer of aerosol research instrumentation since 1966. TSI offers a line of particle instruments that is second to none. Our products for sizing, counting, generating, and dispersing aerosol particles are well known—and well respected—all over the world. We are dedicated to providing our customers with the most innovative particle technology available.

This catalog contains TSI's full line of proven particle instruments. Our particle technology is at the forefront of research, enabling our customers to investigate their cutting-edge research questions. Together with our customers, TSI moves aerosol science - and many associated fields - forward.

Browse through the following pages and let us know how we can help you achieve your research goals.

SHOREVIEW | USA
+1 651 483 0900

AACHEN | GERMANY
+49 241 52303 0

HIGH WYCOMBE | UNITED KINGDOM
+44 1494 4 59200

MARSEILLE | FRANCE
+33 11 41 19 21 99

SINGAPORE
+65 65956388

BEIJING | CHINA
+86 10 8219 7688

SHANGHAI | CHINA
+86 21 8031 1866

BANGALORE | INDIA
+91 80 67877201

Additional contact information appears on the back cover.

Visit our web site for the most current product information available:

www.tsi.com

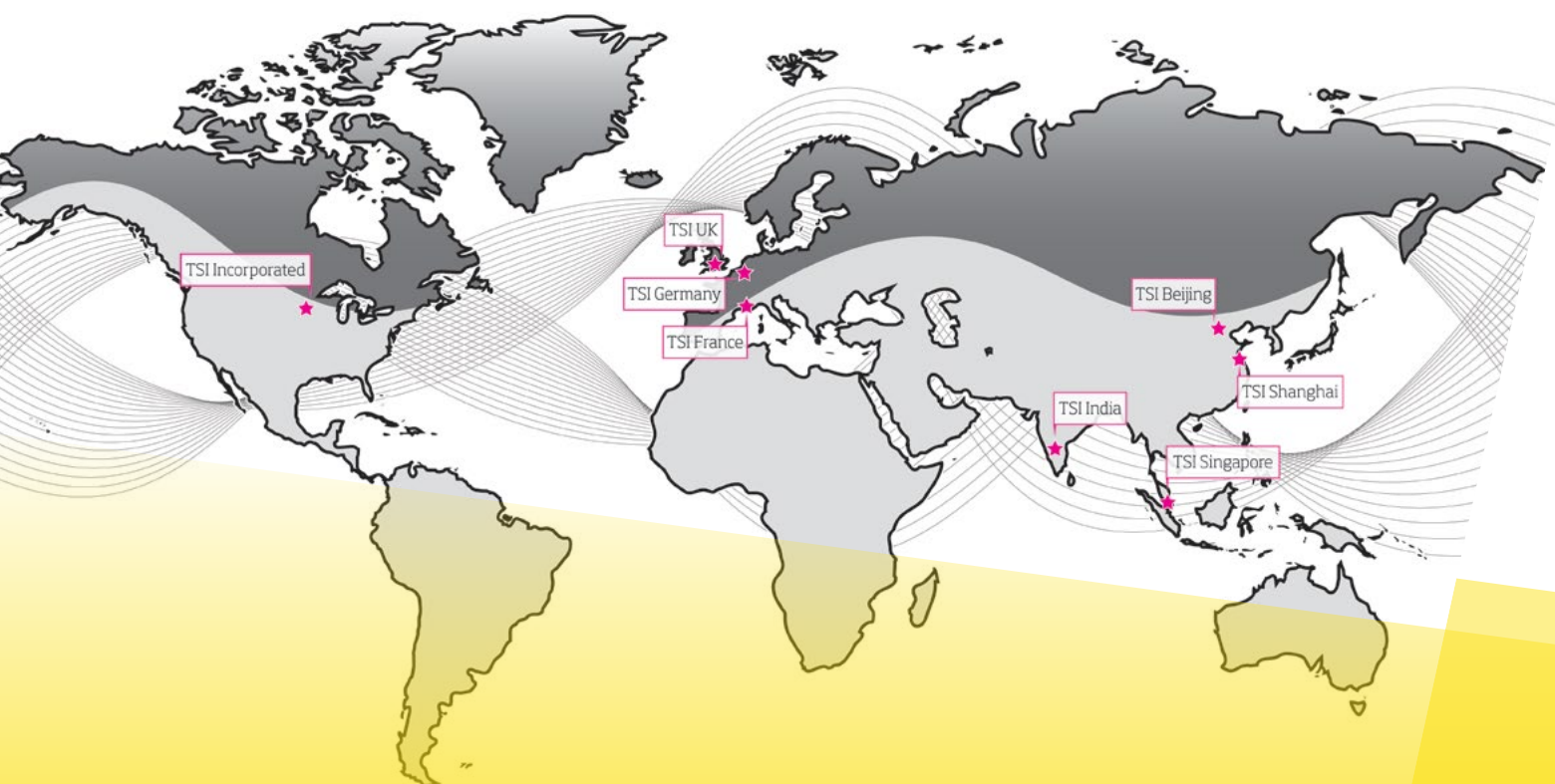

TABLE OF CONTENTS

PARTICLE SIZERS

Scanning Mobility Particle Sizer Spectrometer (Series 3938)	2
Nanoscan Nanoparticle Sizer (3910)	3
Optical Particle Sizer (3330)	4
Aerodynamic Particle Sizer Spectrometer (3321)	5
Aerosol Diluter (3302A)	6
Impactor Inlet (3306)	6
Laser Aerosol Spectrometer (3340A)	7
Fast Mobility Particle Sizer Spectrometer (3091)	8

PARTICLE COUNTERS & DETECTORS

Water-Based Condensation Particle Counters (3783, 3789)	10
Condensation Particle Counters (3750, 3752, 3756, 3757-50)	10
Nano Enhancer (3757)	10
Handheld Condensation Particle Counter (3007)	10
Aerosol Electrometer (3068B)	11
Fiber Monitor (7400)	11

PARTICLE SIZERS & IMAGING SYSTEMS

Phase Doppler Particle Analyzer (PDPA)	12
Particle Image Velocity (PIV)	12
Planar Laser Induced Fluorescent (PLIF)	12

AIR FILTER & RESPIRATOR TESTERS

Automated Filter Testers (8130A, 8130A-EN, 3160)	14
Component Filter-Testing System (3150)	15
Laser Photometer (8587A)	16
Large-Particle Aerosol Generator (8108)	16

ENGINE EMISSIONS & NON-EXHAUST EMISSIONS

Engine Exhaust Particle Sizer™ Spectrometer (3090)	17
Engine Exhaust Condensation Particle Counter (3790A)	18
Nanoparticle Emission Testers (3795, 3795-HC)	20

ENVIRONMENTAL AIR MONITORING

Ultrafine Particle Monitor (3031)	21
Environmental Sampling System (3031200)	21
CEN Condensation Particle Counter (3750-CEN)	21
Atmospheric Aerosol Sampling System (3772200)	21
Dustrak Environmental Monitor	22
DustTrak DRX Aerosol Monitor	22
Sidepak Personal Aerosol Monitor (AM 520)	22

IMPACTORS

Real-time QCM-MOUDI (140)	23
MOUDI Non-Rotating Impactors (100NR, 100S4, 110NR)	24
Mini MOUDI (135)	24
MOUDI-II Rotating Impactors (120R, 122R, 125R)	25
High Flow Impactors (128, 129, 130, 131)	25

AEROSOL GENERATORS & DISPERSERS

Monodisperse Generators (3482, 3940A, 3082, 1520, 3475)	26-28
Process Aerosol Monitor (3375)	28
Polydisperse Generators (3073, 3079A, 3076, 9302, 9306, 9307, 9307-6, 8108, 2045, 2045S)	29-31
Powder Dispersers (3410U, 3410L, 3400A)	32
Seed Aerosol Generators (9302, 9306, 9307, 9307-6, 9308, 9309)	33-34

INSTRUMENTS & ACCESSORIES

Nanometer Aerosol Sampler (3089)	35
Flow Calibrator (4000 Series)	35
Diffusion Dryer (3062, 3062-NC)	36
Aerosol Neutralizers (3088, 3012, 3054, 3077, 348002, 1090)	36
Filtered Air Supply (3074B)	37
Flow Splitter (3708)	37
Particle Size Selector (376060)	38
Vacuum Pumps (3032, 3033)	38
High Flow Sampling System	38



APPLICATIONS

Collectively, our line of particle instruments spans the size range from 0.001 to 2000 micrometers. This unique and comprehensive family of products is used all over the world in a variety of important and interesting applications.

- + Environmental studies
- + Filter testing
- + Diesel and gasoline engine emissions measurements
- + Climate change research
- + Particle formation and growth studies
- + Indoor air quality testing
- + Health effects studies
- + Instrument calibration and standards
- + Basic aerosol research

Ask your TSI representative for information about specific applications, instrument operation, specifications, or new instruments not included in this catalog. To request additional literature or to place an order, call:

US & CANADA: +1 800 874 2811

EUROPE: +49 241 523030

Additional contact information appears on the back cover. Visit our web site for the most current product information available:

www.tsi.com

OPERATIONAL RANGES FOR TSI PARTICLE INSTRUMENTS

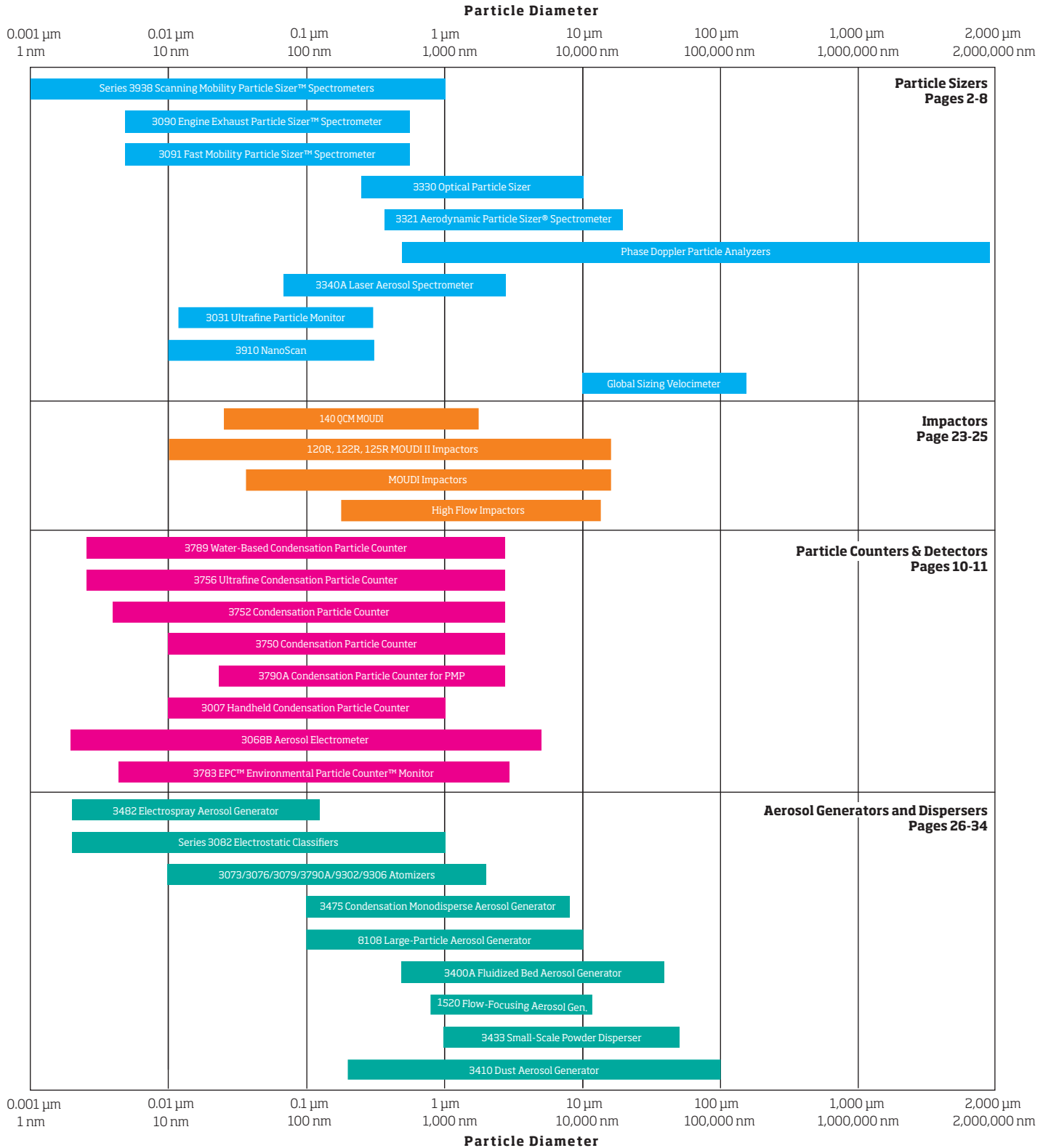

PARTICLE SIZERS

The most comprehensive selection of instruments for sizing submicrometer and supermicrometer particles.

	Sizer	Particle size range (µm)	Particle concentration (#/cm ³)	Measurement time (sec)	Resolution (total channels measured)	Channels per decade	Key feature	DMA	CPC	Condensing liquid		
SMPS	3938L50	0.01 to 1.0	1 to 10 ^{7**}	10 to 600 (selectable)	Varies by model, 192 channels from 0.001 to 1.0 µm, collectively	4, 8, 16, 32, 64, 128 (selectable)	Highest-resolution; individual components provide greatest flexibility	3081A	3750	butanol		
	3938L52	0.01 to 1.0						3081A & 3085A	3752			
	3938N52	0.004 to 0.15										
	3938NL52	0.004 to 1.0										
	3938L56	0.01 to 1.0						3081A	3756			
	3938N56	0.0025 to 0.15						3085A				
	3938NL56	0.0025 to 1.0						3081A & 3085A	3789	water		
	3938L89	0.01 to 1.0						3081A				
	3938N89	0.0025 to 0.15						3085A				
	3938NL89	0.0025 to 1.0						3081A & 3085A				
	3938E89	0.002 to 0.05						3086				
	3938EL89	0.002 to 1.0						3081A & 3086				
	3938E57	0.001 to 0.05						3086			3757 & 3750	diethylene glycol & butanol
	3938EL57	0.001 to 1.0						3081A & 3086				
NanoScan	3910	0.01 to 0.42	1 to 10 ⁶	60	13	8	Portable	Built in			Built in	isopropyl alcohol
FMPS	3091	0.0056 to 0.56	Varies by size*	1	32	16	Fast distributions	n/a			n/a	n/a
APS	3321	0.37 to 20	0.001 to 10 ⁴	1 sec to 18 hours (variable)	52	32	Aerodynamic size					
OPS	3330	0.3 to 10	1 to 3000	1 sec to 24 hours (variable)	up to 16	Variable	High res optical					
LAS	3340A	0.09 to 7.5	1 to 18,000	1 sec to 60 hours (variable)	up to 99		Optical to smaller sizes					

n/a not applicable

* FMPS: 100 to 10⁷ at 5.6 nm, 1 to 10⁵ at 560 nm (1-sec average)

** Upper end of concentration determined by Aerosol Neutralizers Models 3077, 3077A, 3088 specifications



1nm SMPS



3086

3081A

3085A

SCANNING MOBILITY PARTICLE SIZER™ SPECTROMETERS

Model 3938

Our most versatile submicrometer particle sizers provide the highest resolution and accuracy available.

TSI Scanning Mobility Particle Sizer™ (SMPS) systems have advanced to the standard reference in sizing and counting of airborne nanoparticles. The National Institute of Standards and Technology (NIST), and many other reference laboratories worldwide use the TSI SMPS. The SMPS is also compliant to the relatively recent ISO 15900:2009 standard.

It is routinely installed in environmental monitoring stations, filter testers, academic and industrial laboratories. Model 3938 features a selection of modules, which are automatically recognized during setup. It is also the fastest SMPS while providing a very high size resolution.

Collectively, our Series 3938 SMPS™ spectrometers measure particles from 1 to 1,000 nm. They display data up to 128 channels per decade, having up to 200 actual size channels. A very wide concentration range is covered, from 1 to 10,000,000 particles/cm³.

Users may choose among three DMAs, five CPCs, and two different neutralization techniques. This versatility enables you to select a system that best fits your sizing requirements. The Electrostatic Classifier has temperature- and pressure-corrected flow rates for measurements made at elevations other than sea level.

The components can be operated as stand-alone instruments for experiments involving monodisperse aerosol generation or counting the total number of particles.

The end result is an unmatched, proven solution for research involving combustion, atmospheric aerosols, indoor air quality, filter testing, and much more.

When an SMPS is coupled with an OPS or APS, the continuous measurement range can be extended up to 10 μm or 20 μm, respectively. Paired with a QCM MOUDI real-time impactor the density of a size fraction of particle can be determined.

Upgrade your older SMPS™ system.

Customers with series SMPS 3936 spectrometers can upgrade to a Series 3938 system. Call your TSI representative for information on a special promotion for you and your system.

SMPS Accessories (available separately)

Specify	Description
1090	Electrical Aerosol Neutralizer
3077/3077A	Aerosol Neutralizer
3089	Nanometer Aerosol Sampler (not CE)
3088	Soft X-Ray Neutralizer

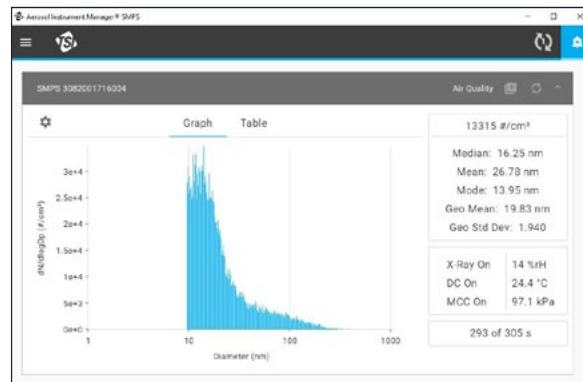

SMPS component systems give you the highest-resolution particle size data.

NANOSCAN SMPS NANOPARTICLE SIZER

Model 3910

Affordable, portable nanoparticle sizer for particles down to 10 nm.

TSI's NanoScan SMPS opens the door to routine nanoparticle size measurements for everyone. This revolutionary sizer fits a TSI SMPS™ Spectrometer into an affordable, portable package that is about the size of a basketball. Easy to use, lightweight, and battery-powered, the NanoScan SMPS enables investigators to assess airborne nanoparticle concentration and size in workplaces, schools, hospitals, without complicated setup. Size distributions are measured from down to 10 nm for concentrations up to 1,000,000 particle/cm³. Derived from TSI core technologies, the NanoScan SMPS is an innovative, cost-effective solution for real-time nanoparticle size measurements.

Data collection begins with a touch of the instrument display - no need for a dedicated computer to set up the instrument or save data. The user interface is intuitive and easy for new users to operate. NanoScan SMPS displays real-time number, surface area, or mass size distributions, concentrations, and statistics. From the front panel, users can program start time, number of samples, and other parameters. A full suite of instrument diagnostic data gives the user security and ensures the data quality.

In addition to nanoparticle size distributions, the NanoScan SMPS can collect second-by-second concentration data at a single mobility diameter. If the nanoparticle source of concern generates 50 nm particles, it is possible to easily monitor 50 nm mobility diameter with 1 second time resolution to keep a real-time record of concentration levels.

Combine the NanoScan SMPS and the Optical Particle Sizer Model 3330 to measure three orders of size magnitude from 10 nm to 10 μm using affordable MIM software in concert with portable, real-time instruments.

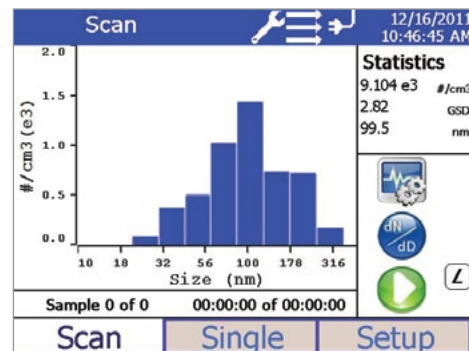
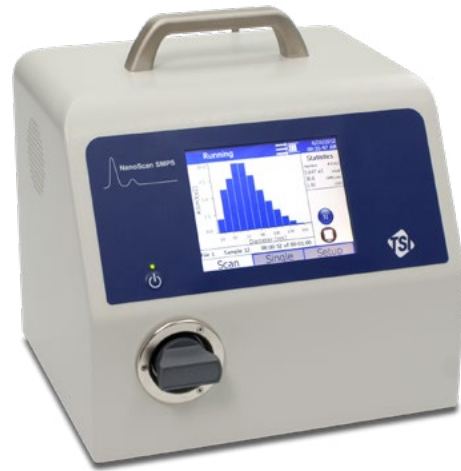

Screen shot of NanoScan SMPS during nanoparticle size distribution measurement.

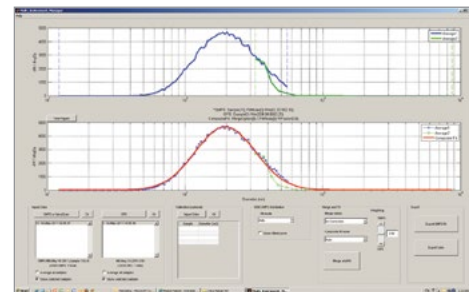

Screen shot of MIM software.

Nanoscan Accessories (available separately)

Specify	Description
3062-NC/3062	Diffusion Dryer

OPTICAL PARTICLE SIZER

Model 3330

Easy-to-use particle sizer for particles 0.3 - 10 µm in size.

Optical Particle Sizer 3330 (OPS) is a light, portable unit that uses single-particle counting technology to provide fast, accurate measurement of particle concentration from 0 to 3,000 particles/cm³ and particle size distribution for 0.3 - 10 µm in up to 16 channels. Backed by over 40 years of aerosol instrumentation design experience, the OPS uses state-of-the-art optics with 120° light collection and sophisticated electronics processing resulting in precision, high-quality data. The affordable, easy-to-use package features a color touch screen with an intuitive user interface. Rigorous factory calibration standards ensure measurement accuracy.

In addition to improving the core measurement fundamentals, the Model 3330 includes the ability to enter the index of refraction and shape factor of the aerosol into the software to provide more accurate size distributions. The size boundaries can be adjusted using both real and imaginary components of refractive index. A unique density for every size channel can also be entered into the software to further improve mass concentration measurements.

The Model 3330 is manufactured at TSI's ISO 9001 certified facility. It is calibrated according to ISO 21501-1 using NIST traceable PSL spheres and TSI's accredited Electrostatic Classifier and Condensation Particle Counters. PSL is the industry-wide calibration aerosol of choice because it has properties close to many real world aerosols and is traceable to national standards throughout the world. Each OPS that leaves the factory is built for longevity, backed by TSI's commitment to quality, and supported by our worldwide network of committed TSI professionals.

Applications:

- + Filter Testing
- + Indoor Air Quality
- + Workplace Monitoring
- + Industrial Measurements
- + Hotspots



OPS Model 3330 setup screen.

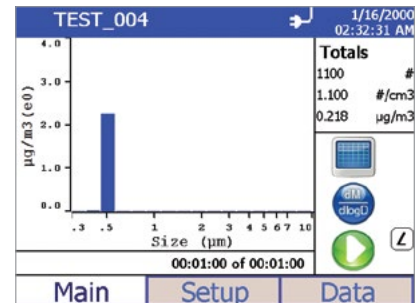

Mass size distribution for 0.49 µm classified PSL spheres.



Environmental Enclosure

OPS Accessories (available separately)

Specify	Description
3332-10	10:1 Diluter
3332-100	100:1 Diluter
8535	Environmental Enclosure

AERODYNAMIC PARTICLE SIZER® SPECTROMETER

Model 3321

The only way to determine a particle's true airborne behavior is to measure its aerodynamic diameter.

Aerodynamic measurements account for differences in particle size, shape, and density. This is crucial when determining if a particle will penetrate a filter, be removed by a cyclone, or be deposited in the lung. The Aerodynamic Particle Sizer (APS™) spectrometer has been used successfully for over 20 years in laboratory and field applications to provide high-resolution, real-time aerodynamic measurements in the range from 0.5 to 20 µm. Our latest models also measure light-scattering intensity in the equivalent optical size range of 0.37 to 20 µm. By providing paired data for each particle, the APS opens up exciting new possibilities for aerosol scientists interested in studying the makeup of an aerosol.

The Model 3321 APS spectrometer uses a patented, double-crest optical system for unmatched sizing accuracy. It also includes a redesigned nozzle configuration and improved signal processing. The result is greater small-particle sizing efficiency, improved accuracy of mass-weighted distributions, and near elimination of false background counts. The Aerosol Instrument Manager® software provides advanced data-handling capabilities.

Applications:

- + Atmospheric Monitoring for Supermicron Particles
- + Air Cleaner Performance Testing
- + Biological Aerosol Research
- + Inhalation Toxicology



APS software has advanced instrument-control and data-handling features.

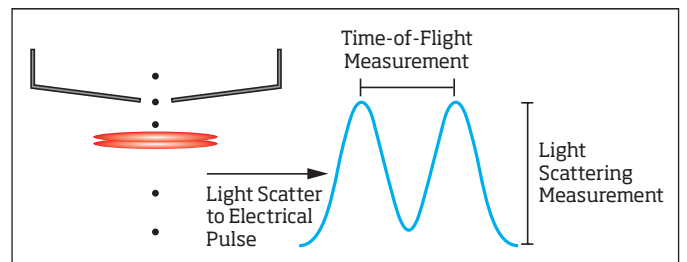

3321 APS time-of-flight measurement

APS Accessories (available separately)

Specify	Description
3302A	Aerosol Diluter
3306	Impactor Inlet
3433	Small-Scale Powder Dispenser (not sold in Europe)
3410L	Dust Generator (Low)
3410U	Dust Generator (Ultralow)

AEROSOL DILUTER

Model 3302A

Dilutes high-concentration aerosols for use with the Aerodynamic Particle Sizer® (APS™) spectrometer.

This diluter reduces particle concentrations of high-concentration aerosols, providing a representative sample that meets the input requirements of the APS spectrometer. The 3302A achieves dilution ratios of 100:1 and 20:1 using easy-to-change capillary tubes. Two diluters in a tandem configuration provide dilution ratios as high as 10,000:1.

Engineered to provide very low particle loss in the 0.5 to 10 µm size range, the Aerosol Diluter is totally self-contained and requires no outside power or compressed gas. Durable construction and simple maintenance procedures translate into years of trouble-free operation.



IMPACTOR INLET

Model 3306

Collects a size-segregated sample for mass or chemical analysis while making APS measurements.

An accessory for our APS, the 3306 combines a single-stage impactor with a filter. It takes a size-segregated sample and directs a diluted (80:1), representative portion of the initial test aerosol into the particle sizer for measurement. The inlet aerosol passes through a single-stage impactor (2.5 or 4.7 µm, 50% cut size) and is collected with an after-filter for later mass or chemical analysis. Model 3306 includes two inlet throats: one for standard applications; the other for pharmaceutical research. (APS sold separately)



Accessory (available separately)

Specify	Description
3033	Vacuum Pump

LASER AEROSOL SPECTROMETER

Model 3340A

Optical Particle Sizing down to 90 nm.

TSI's Laser Aerosol Spectrometer 3340A is a high sensitivity, high-resolution, optical particle sizer. This "turn on and measure" instrument allows users to easily measure particle size distributions from 0.09 (90 nm) to 7.5 μm in seconds. The specialized laser and optics overcome the limitations of lower-class optical particle counters, and enhance the resolution and sensitivity of detection.

The 3340A is a handy tool to have for monitoring your filters or your processes, measuring in a lab, or sampling on field campaigns. The Laser Aerosol Spectrometer became a de facto standard in Air Cleaner Testing (CADR).

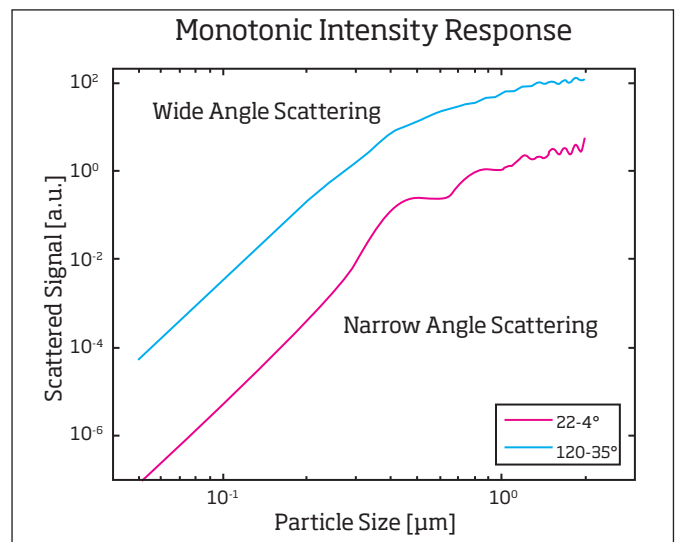

The 3340A uses a wide angle light collection to get a monotonic response over a wide range of particle sizes.

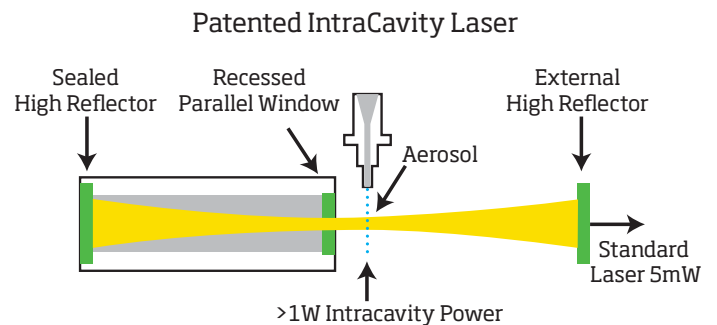

FAST MOBILITY PARTICLE SIZER® SPECTROMETER

Model 3091

Measures size distribution and number concentration of rapidly changing, submicrometer aerosol particles in real time.

The Fast Mobility Particle Sizer (FMPS™) spectrometer measures particles in the range from 5.6 to 560 nm, offering a total of 32 channels of resolution (16 channels per decade). This submicrometer particle sizer uses an electrical mobility measurement technique similar to that used in the SMPS spectrometers. However, instead of a CPC, the Model 3091 FMPS spectrometer uses multiple, low-noise electrometers for particle detection. This produces particle-size-distribution measurements with 1-second resolution, providing the ability to visualize particle events and changes in particle size distribution in real time.

The Model 3091 operates at a high flow rate (10 L/min) to minimize diffusion losses of ultrafine and nanoparticles. It operates at ambient pressure to prevent evaporation of volatile and semivolatile particles. It requires no consumables. Plus, it uses an efficient, unipolar charger to eliminate the need for a radioactive neutralizer.

The FMPS is easy to transport, set up, and operate. It can be configured to measure single or multiple runs continuously for up to 12 hours. Its large, color VGA display and built-in control knob provide easy access to instrument functions, set-up menus, and data displays. Software highlights include a variety of graphing options, including 3-D playback of size distribution and concentration versus time, data export capabilities, and the ability to input individual effective densities per channel to calculate a continuous output of total particulate mass.

All of these features make the FMPS spectrometer appropriate for a variety of applications, especially particle formation and growth studies, indoor-air-quality measurements, environmental research, inhalation toxicology studies, urban canyon studies, and transient emission studies from stacks, boilers, and wood burners.

Developed by TSI Incorporated under license from Airel, Ltd. of Tartu, Estonia.

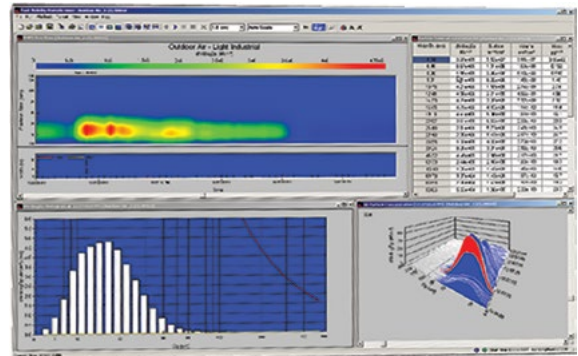
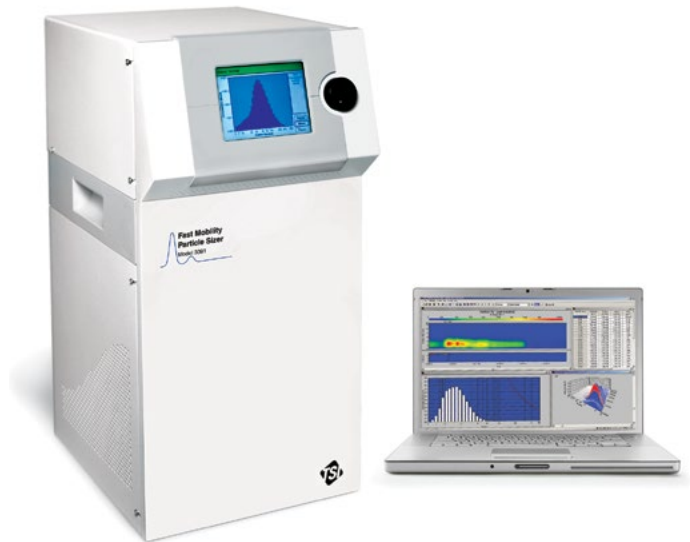



PARTICLE COUNTERS AND DETECTORS

In environmental research and monitoring, customers face high concentrations in city centers, near freeways or harbors, or very low concentrations in remote locations which are used as reference sampling points.

In the laboratory, particle counters are often combined with particle sizers to measure size distributions. Workplaces, hospitals, schools, residential homes and other sensitive environments prefer water-based Condensation Particle Counters to ensure the occupants' safety and health. Combustion aerosols provide challenges, such as sampling the aerosol without changing it, or following regulatory directives for engine exhaust.









CONDENSATION PARTICLE COUNTERS

TSI introduced its first Condensation Particle Counter in 1978. Since then, we have developed the technology further, working together with the research community. Today we have the most modern, reliable and successful selection of CPCs, operating with water, butanol, isopropanol or diethylene glycol.

The applications for CPCs are very numerous. CPCs are used around the world to count particles in air accurately - either in laboratory setups, in sensitive environments (schools, workplaces), in vehicle emissions, or in the atmosphere to monitor air quality. Our CPCs detect particles as small as 1 nm, count particles at up to 50 Hz and complement our fast-scanning nanoparticle sizer (SMPS).

TSI has a great depth of experience in designing and manufacturing CPCs, and in supporting users in their CPC applications. With so many choices, let us help you to find the solution for your measurement challenge.

CPC COMPARISON CHART

	3007	3750 & 3750-CEN*	3752	3756	3757-50	3790A	3783	3789
Specifications								
D50 Min. Size (nm)	10	7	4	2.5	1***	23	7	2.2, 7, custom
Max. Concentration (particles/cm³)	100,000	100,000	100,000; up to 10 ⁷ **	300,000	300,000	10,000	1,000,000	200,000
Concentration Accuracy (%)	± 20	± 5	± 5; ± 20**	± 10	± 10; ± 15**	± 10	± 20	± 5
Sample Flow (LPM)	0.1	1.0	0.3	0.05	1.0	1.0	0.12	0.3
Total Inlet Flow Mode (LPM)	0.7	1.0	0.3 1.5	0.3 1.5	2.5	3.0	0.6 3.0	0.6 1.5 2.5
Response - T95 (s)	< ~3	~2	< 4 < 3	< 3 < 1	1.9	< 5	< 5 < 3	< 1
Response - T10-T90 (s)	(no data)	< 1	< 2 < 1.5	< 2 < 0.2	1.5	(no data)	(no data)	0.6
Flow Source	Internal	External	Internal		External	External	External	Internal
Working Fluid	Isopropyl	Butanol			Butanol and DEG	Butanol	Water	
Weight	1.7 kg	6.6 kg (~14.6 lbs.)	9.1 kg (~20 lbs.)		<20 kg (<44 lbs)	5.5 kg (12 lbs)	~10 kg (~22 lbs)	8.2 kg (18 lbs)
Display	Digital LCD	Embedded touch display				LCD	Embedded touch display	
Data Logging/Storage	Internal memory	Internal memory				SD/MMC flash card	Flash Drive	Internal Memory
TSI SMPS Compatibility	No	Yes (3082 classifier)				No	No	Yes (3082)
Pulse Height Monitor	No	Yes				Yes	Yes	
Data Resolution (Hz)	1	50				10	1	50
Additional Features	Battery-powered operation	On-board data acquisition with remote access and control Fully operable through Ethernet connection				90% counting efficiency at 41nm	Water use ~ 250 mL/wk.	(same as 3750-series)

T95: Rise from 0 to 95% or decrease to zero from 95% (fall time); TSI's traditional approach
T10/90: Rise 10% to 90%, fall 90% to 10%

* 3750-CEN is available by applying a CEN calibration to an otherwise-standard 3750

** 3752: Above 100,000 particles/cm³ the 3752 uses photometric mode which has concentration accuracy of ±20%

3757-50: ± 10% below 1.65 x 10⁵ particles/cm³; ± 15% at 3 x 10⁵ particles/cm³

*** 1.4 nm electrical mobility diameter, 1.1 nm geometric diameter. Verified with NaCl particles

AEROSOL ELECTROMETER

Model 3068B

A reference standard for particle concentration.

This reference instrument provides accurate measurements of total net charge on aerosol particles from 0.002 to 5 µm. In combination with a monodisperse aerosol generator it serves as a particle number concentration reference standard.

- + High sensitivity of ±1 fA for accurate and sensitive measurements
- + Wide dynamic range with no range settings (±12,500 fA)
- + Temperature stabilized to significantly reduce drift
- + Automatic flow control (0.3 to 10 L/min) with accuracy down to ±3 %
- + Low internal particle losses
- + Fundamental particle concentration measurement when used with a TSI Electrostatic Classifier
- + Wide particle size range (0.002 to 5.0 µm)



Accessory (available separately)

Specify	Description
3033	Vacuum Pump

FIBER MONITOR

Model 7400

Detecting fibers in air in real-time.

The 7400 is a technologically advanced real-time fiber monitor that detects and counts airborne respirable fibers such as asbestos, mineral wool, advanced composites, ceramic and glass. The Real-Time Fiber Monitor is factory-calibrated with traceability to NIOSH Method 7400 for asbestos fibers. The 7400 largely ignores non-fibrous background particles using the proven principle of electric-field-induced fiber alignment and oscillation.

Applications

- + Asbestos abatement operations to monitor success and ensure worker safety
- + Monitoring in manufacturing operations that use raw fiber materials
- + Monitoring airborne fibers that result from uncontrolled releases, such as fires, earthquakes or explosions



PARTICLE SIZERS & IMAGING SYSTEMS

COMBUSTION DIAGNOSTICS

TSI is a complete solutions provider across multiple disciplines. Our Fluid Mechanics section offers measurement solutions to gain insights into combustion processes from a different, but complimentary perspective.

Spray nozzle outputs a complex field of high air flows, gases and droplets. Particle Image Velocity (PIV) is an example of a technique visualizing the gases and droplets exiting the spray nozzle. Typically high-pressure injection nozzles are used to inject fuel into the combustion chamber. The spray field is a critical design to optimize the combustion process.

A Particle Imaging system can be used to analyze the spray to help the design of the nozzle.

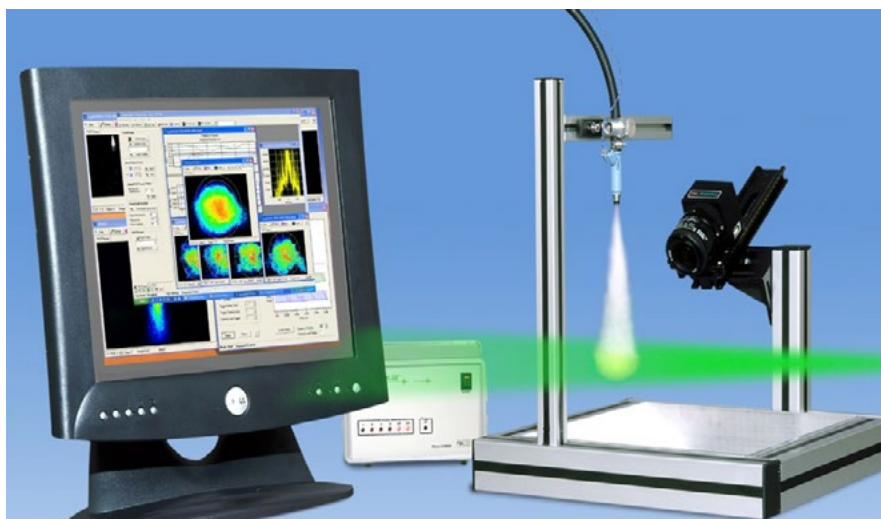

Measuring Technique	Characteristics	Measurement Results
Planar Laser Induced Fluorescent (PLIF) Imaging System	Flame radicals in reaction zone	Species concentration of OH and CH
Planar Laser Induced Fluorescent (PLIF) Imaging System	Flame pollutant analysis	Species concentration of NO, CO, and SO ₂
Laser Induced Incandescence (LII) System	Soot analysis in flame	Concentration and size profile of soot
Laser Induced Filtered Rayleigh Scattering (LRS) System	Flame temperature	Profile of temperature
Particle Image Velocity (PIV) System	Flame velocity and mixing	Velocity field in flame
Phase Doppler Particle Analyzer (PDPA) System	Flame velocity and propagation	Velocity and size of particulates

AIR FILTER & RESPIRATOR TESTERS



Our automated air filter and respirator testers are known for easy, efficient, and reliable operation. Component systems are also available.

Model	8130A ^a	3160
Measurement Application	Loading and Quality Control Tests	MPPS
Maximum Efficiency	99.9999% (oil aerosol)	99.999999%
Aerosol Type ^b	DOP, PAO, DEHS, Paraffin, and other Oils or NaCl	DOP, PAO, and other Oils or NaCl
Aerosol Generation	Atomizer	Atomizer with Classifier
Count Median Diameter ^c	0.2 µm (Oil) or 0.075 µm (NaCl)	N/A
Geometric Standard Deviation ^c	<1.6 (Oil) or < 1.86 (NaCl)	<1.3
Flow Rate	10 to 110 L/min	5 to 100 L/min
Resistance	0 to 255 mm H ₂ O (0 to 2500 Pa)	0 to 150 mm H ₂ O (0 to 1470 Pa)
Particle Detection	Light Scattering Photometer	Condensation Particle Counter
Typical Test Length	10 sec	30 sec to 20 min ^d
Data Reporting	Alpha-Numeric Display and RS-232 Touch screen and RS-232	PC with Integrated Software
Operation	Stand-alone Tester/ Automated Production Lines	Stand-alone Tester
Compliance	US 42 CFR part 84, EN 143, JMOL, ISO 23328-1	EN 1822 parts 3 and 5

a) EN versions (for equivalent results to EN 143 standard) available (8127-1-EN, 8130A-EN)
 b) Aerosol abbreviations: DOP (dioctyl phthalate), PAO (polyalpha olefin), DEHS (di-ethylhexyl sebacate)
 c) EN version CMD and GSD are different. See 8127/8130 spec sheet for more info
 d) Efficiencies higher than 99.9999% require longer than typical testing times

AUTOMATED FILTER TESTERS

Models 8130A & 8130A-EN

Filter testers for commercial respirator and military mask testing.

The Automated Filter Tester Model 8130A continues to be the best solution for testing particulate respirator filters, disposable filtering face pieces, and a wide assortment of filter media. It has a high degree of automation and self-diagnostics that greatly simplify operation, increase throughput, and improve overall measurement performance. This stand-alone tester will determine penetration or filter efficiency and pressure drop of your media, filter cartridges, filters, and respiratory masks. The built-in capability to test with salt and oil means that just one unit is needed to test your product to: US 42 CFR 84, GB2626, JMOL, ISO 16900-3, EN 143, ISO 23328-1 and more.



Model 3160

Determines penetration vs. particle size of filters and filter media.

Model 3160 is the most advanced automated tester available for challenging filters and filter media with submicrometer aerosols. It can be used to test both low- and high-efficiency filters and filter media, up to 99.999999% efficient (eight 9's), or penetrations down to 0.000001%.

The 3160 uses a bank of atomizers and the TSI Electrostatic Classifier to challenge a filter or filter media with size-controlled, monodisperse particles. Two Condensation Particle Counters (CPCs) simultaneously count the upstream and downstream particles and computer software calculates the penetration value. Filters can be sequentially challenged with up to 20 different monodisperse particle sizes from 15 to 800 nm. The penetration value for each particle size is calculated. At the end of a test, the 3160 generates a curve of penetration vs. particle size and produces a summary of test results, including the most penetrating particle size (MPPS). Test results can be automatically saved in a Microsoft® Access® data base and downloaded into Microsoft® Excel®.

Model 3160 complies with EN 1822-3, EN 1822-5, ISO 29463-3, and ISO 29463-5, and provides the most complete information on filter penetration available from any filter tester. You'll find it invaluable for product development and quality control.



COMPONENT FILTER-TESTING SYSTEM

Model 3150

Modular off-the-shelf solution for your custom air filter testing needs.

For the wide range of flow rates and particle sizes needed to meet the requirements of the many filter-testing standards and research needs, an automated tester is not always practical. Building a filter test system from components is often the best way to satisfy your measurement needs. TSI has developed the Component Filter Test System (CFTS) as an easy-to-use system to integrate all the necessary parts of this type of system.

The Model CFTS 3150 from TSI consists of software and a hardware module to provide an off-the-shelf solution for all your custom filter-testing needs. Pre-configured to work with TSI's world-class detectors and sizers, the CFTS provides a platform for numerous filter test applications.

Because filters are used for a wide variety of applications and are tested to many different filter test standards, you need a filter-testing system that is flexible enough to change to meet these various standards. The CFTS system is designed for this flexibility. It measures flow using a variety of techniques and controls blowers to achieve the required flow. It has multiple ports used to read temperature, pressure, and relative humidity, then make flow corrections and log sensor data for test reports. Whether designing a new test duct or updating an existing system, the CFTS provides an easy-to-use system with the flexibility to meet your filter-testing needs.

CFTS is structured as a core platform which controls the filter test. Its graphical user interface is used to define the test layout and procedures as well as being your interface for running the test. The CFTS has drivers to communicate with the particle instruments and is the interface for reading sensors and controlling flow. During testing, it collects, saves, and exports the data needed for test reports. No longer is custom software required for every component change.

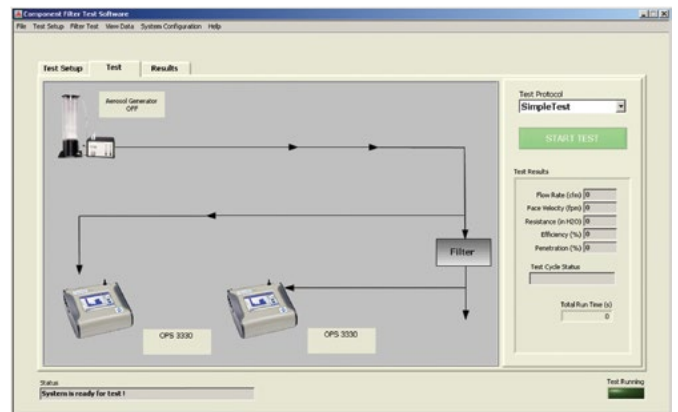

CFTS software screen shot.

Compatible Instruments

Specify	Description
3330	Optical Particle Sizer
8587A	Laser Photometer
375X	Butanol-CPC series
7110	Aerotrak Remote Particle Counter
3082L	
(3082 and 3081A)	Electrostatic Classifier and Differential Mobility Analyzer

LASER PHOTOMETER

Model 8587A

A compact, reliable photometer for customized filter testing.

This photometer features a reliable laser diode that produces constant laser power, so aerosol concentration measurements remain stable over a long period of time. A sheath-air design keeps the optics clean for low background levels and minimal maintenance requirements. The 8587A uses an internal switching valve to measure both the upstream and downstream aerosol concentration. A special high-speed "purge" mode shortens the purge time when switching between upstream and downstream measurements. A simple command set can be incorporated into your LabVIEW® program to give you complete flexibility in test protocol and database management. All of these features combine to make the 8587A ideally suited for custom filter testing applications.



LARGE-PARTICLE AEROSOL GENERATOR

Model 8108

Generates high-concentration aerosols up to 10 µm in diameter.

The Large-Particle Aerosol Generator produces highly concentrated aerosol over a wide particle-size range, from 0.1 to 10 µm. Designed for easy cleaning, this generator produces potassium chloride (KCl) and other aerosols. Model 8108 meets the requirements of ASHRAE 52.2 for KCl test aerosol and can also be used for ISO/TS 11155-1:2001 filter efficiency testing. It is an ideal aerosol generator for fractional efficiency testing of general ventilation filters and automotive cabin-air filters.



ENGINE EMISSIONS & NON-EXHAUST EMISSIONS TESTERS

ENGINE EXHAUST PARTICLE SIZER™ SPECTROMETER

Model 3090

The best tool for measuring transient particle emissions and characterizing exhaust after-treatment devices.

The Engine Exhaust Particle Sizer (EEPS™) spectrometer measures the size distribution of engine particle emissions in the range from 5.6 to 560 nm with the fastest time resolution available (10 times per second!). Users can visualize and study the dynamic behavior of emissions that occur during transient test cycles, such as changes in engine speed, torque, or load. They may also measure emissions that occur during the first few seconds of a cold start or during regeneration of a particle trap or diesel particulate filter (DPF).

Measurements are displayed with high size resolution (32 total channels, 16 channels per decade). The EEPS spectrometer operates over a wide particle concentration range, which makes it well-suited for measuring upstream and downstream of a particle trap or DPF to determine soot loading and removal efficiency. The EEPS operates at ambient pressure to prevent evaporation of volatile and semivolatile particles, requires no consumables, and uses an efficient, unipolar charger to eliminate the need for a radioactive neutralizer. Users can select from multiple matrices tailored to specific aerosols for more accurate measurement.

Ease of operation is a key feature of this instrument. All components, including the vacuum source, are housed in a single cabinet that weighs just 32 kg (~70 lbs). Just turn on the power and allow the instrument to warm up. A microprocessor corrects for volumetric flow and barometric pressure automatically. This will maintain calibration and provide accurate particle size distribution information. The EEPS also features an external "start" input trigger for remote operation, two analog inputs to log and correlate other engine parameters, and four user-configurable analog outputs to integrate emission measurements with the test cell host computer.

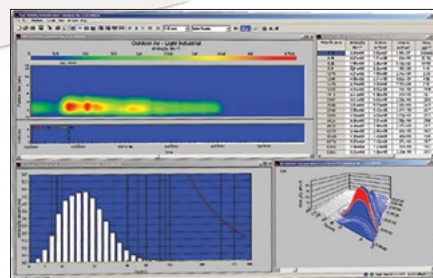

Applications:

- + Gasoline Direct Injection Engine Emissions
- + Diesel Exhaust
- + Brake and Tire Emissions
- + Cold Start
- + Engine and After Treatment Development

EEPS software allows users to display measurements in a variety of graphical and tabular formats, including 3-D viewing of size distribution and concentration versus time. These can be replayed for a unique "movie" view of the entire engine cycle, or you can zoom in on a period of interest. The software includes a data export capability and allows users to input individual effective densities per particle size channel to calculate a continuous output of total particulate mass.

The EEPS spectrometer was developed by TSI Incorporated under license from Airel, Ltd. of Tartu, Estonia. Additional assistance was provided by the University of Minnesota Center for Diesel Research.

ENGINE EXHAUST CONDENSATION PARTICLE COUNTER

Model 3790A

The particle number (PN) concentration benchmark for ECE Regulations 83 and 49.

The Engine Exhaust Condensation Particle Counter (EECPC) accurately measures PN concentration of exhaust emissions. In fact, the GRPE Particle Measurement Programme (PMP) concluded that PN measurements using a CPC plus thermodilution are 20 times more sensitive and much less variable than the traditional method (i.e., gravimetric filter analysis). As a result, the measurement of solid PN emissions has been included in Regulation 83 (Euro 5) for certification of new passenger vehicles with diesel engines, and later for Regulation 49 (EURO 6) for heavy-duty engines.

Model 3790A EECPC is fully compliant for light-duty vehicle certification in accordance with all Regulation 83 requirements. The Model 3790A EECPC incorporates a wide assortment of design improvements and features such as anti-spill design, condensate removal, removable saturator for ease of maintenance, built-in microprocessor with USB, RS-232 and Ethernet communication interfaces, touch-panel membrane keys and a display that enables instrument set-up, viewing particle concentration and count data, interrogating instrument status, and data storage capabilities. The EECPC includes our Aerosol Instrument Manager® software. An external vacuum pump is required - sold separately.



Accessory (available separately)

Specify	Description
3032	Vacuum Pump

POROUS TUBE THERMODILUTER

Model 3098

The Model 3098 Porous Tube Thermodiluter (PTT) is the next generation sample conditioning system specifically designed for the 3090 Engine Exhaust Particle Sizer (EEPS™) spectrometer to characterize advanced combustion designs and solid particle emissions from modern engines.

The PTT employs two porous tube diluters with a catalytic stripper (CS) to remove volatile species along with advanced mass flow controllers to provide real-time dilution ratio measurement and control.

Applications:

- + Diesel, gasoline and compressed natural gas engine exhaust measurements
- + Cold start engine emissions
- + Sub-23nm solid particle emissions
- + Non-road machinery emissions
- + Exhaust after-treatment (DPF or GPF) characterization (Pre-DFF/GPF sampling with optional Pressure Reducing Module PN 3098-PR)
- + Emission characterization from biomass combustion and garbage incinerators
- + Brake and tire wear particle emissions

Additional features and benefits of the 3098 PTT include:

- + When combined with EEPS™ Spectrometer, it allows users to get accurate measurement of solid particle number and mass size distributions in real-time
- + PMP-type (hot dilution-catalytic stripper-cold dilution) sample conditioning at ambient pressure for measurement of solid particles
- + Reliable performance: well controlled/stable/known dynamic dilution ratio
- + Low thermophoretic and diffusional losses
- + Robust design: no moving parts to wear out
- + Swappable flow controller module
- + Low cost of ownership (only flow control module needs to be calibrated)
- + Easy to use: Integrated for EEPS™ Spectrometer



NANOPARTICLE EMISSION TESTERS

Models 3795 & 3795-HC

Solid Particle Measurements

Sampling from combustion sources is often challenging due to the presence of volatile material. Volatile components are extremely sensitive to sampling conditions and can grow existing particles and form new particles through condensation. By evaporating and oxidizing volatile components and particles, the Nanoparticle Emissions Tester (NPET) Model 3795 measures only the remaining solid particles.

Portable and Accurate

The Model 3795 NPET helps you bring laboratory-grade particle counting to your worksite. The NPET features a sampling probe compatible with tailpipes, built-in 10:1 dilution, and a catalytic stripper to remove volatile particles. The results are comparable to type-approval instruments.

The NPETs are applied to various emission sources, such as tailpipes (diesel or gasoline combustion engines), wood stoves, or biomass or waste conversion power plants. The NPET serves also as reference unit in the on-going research of in-use testing of vehicles.



Official Certification Testing

The NPET fully meets Swiss Regulation 941.242 for the periodic certification of diesel-powered machinery equipped with a DPF.

General Emission Testing

The High Concentration NPET model 3795-HC was developed to assist the DPF manufacturers, engine developers and fleet managers to assess nanoparticle emissions and the efficiency of the after-treatment systems. The 3795-HC is independent of the Swiss regulation and is capable of measuring even raw exhaust gas emissions up to 100,000,000 particles/cm³.

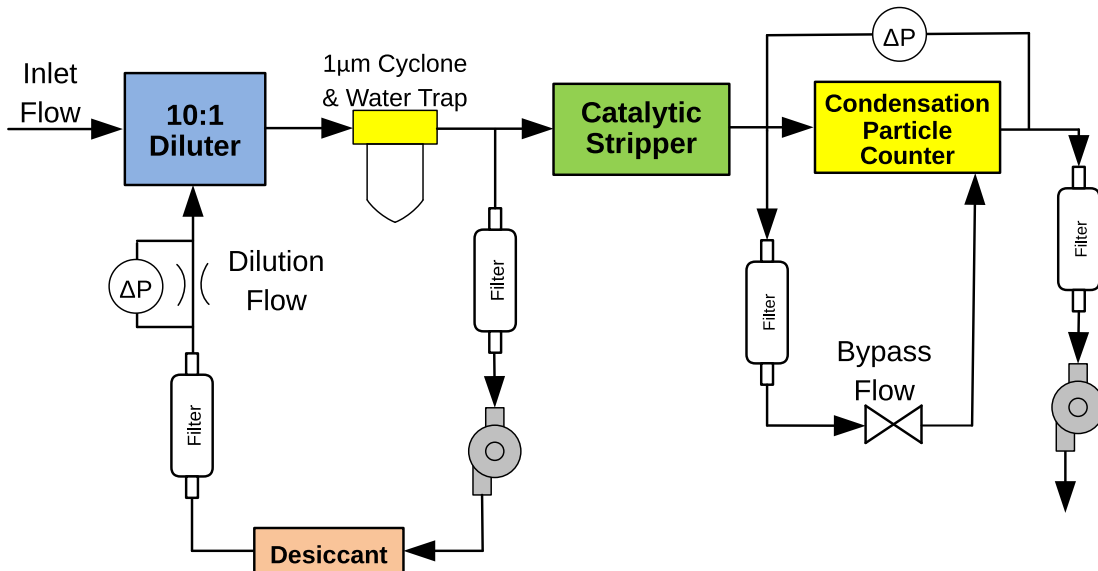

ENVIRONMENTAL AIR MONITORS

ULTRAFINE PARTICLE MONITORS

Model 3031

Provides continuous size distribution (6 channels, 20 nm to 1,000 nm) and number concentration data for long-term air quality monitoring.

The Model 3031 Ultrafine Particle (UFP) Monitor has been specifically designed for air-quality monitoring networks. It operates continuously, 24-hours a day, with minimal maintenance. The Model 3031 fits into a standard 19-inch, rack-mount cabinet, which allows it to be easily installed into existing roadside and urban-air-quality monitoring stations.

The matching sampling system provides representative sampling and proper conditioning of ambient submicrometer aerosol for accurate size distribution and particle number concentrations.

The Model 3031200 consists of a standard PM10 inlet, a sharp-cut PM1 cyclone, a flow splitter, and a Nafion® dryer. Combine these components with your choice of appropriate-length sampling tubes and vacuum source for easy setup in the field.



Accessory (available separately)

Specify	Description
3031200	Environmental Sampling System
3033	Vacuum Pump

Model 3750-CEN

As a first step in harmonizing the measurement of UFPs in the atmosphere, the European Committee for Standardization (CEN) drafted the Technical Specification CEN/TS 16976 which defines a set of requirements for the Condensation Particle Counter (CPC) and the sampling system.

The Model 3750-CEN CPC is fully compliant with CEN/TS 16976. Your order includes the verification and calibration by the World Calibration Centre for Aerosol Physics, Leibniz Institute for Tropospheric Research (TROPOS).

The sampling system (model 3772200) conditions the aerosol according to the technical specifications of CEN/TS 16976 such as less than 30% particle loss for 7 nm particles and an aerosol dryer. It can be combined with the 3750-CEN CPC but also with other nanoparticle counters from TSI such as the SMPS 3938L50.



DUSTTRAK™ ENVIRONMENTAL MONITOR

Whether working at a construction site, engineering firm or managing the aftermath of wildfires, the DustTrak™ Environmental Monitor is a robust, reliable solution for environmental monitoring. This instrument is compatible with a variety of sensors to detect volatile organic compounds (VOCs), gases, wind speed and more. TSI also offers a cloud-based management system, allowing you to access data anytime and anywhere.



DUSTTRAK™ DRX AEROSOL MONITOR

Models 8533, 8533EP & 8534

DRX monitors are light years ahead of any other. The DustTrak DRX monitor, for instance, simultaneously measures both mass and size fraction. Measure PM1, PM2.5, Respirable, PM10 and TPM simultaneously with no need for size-selective inlet conditioners.



SIDEPAK™ PERSONAL AEROSOL MONITOR

Model AM520

The SidePak™ Personal Aerosol Monitor AM520 is a small, portable, battery-operated, data-logging, light-scattering laser photometer that provides real-time aerosol mass concentration readings of dusts, fumes, mists, smoke and fog within a worker breathing zone. Newly designed inlet conditioners increase the mass concentration capability and provide size fraction cut points for PM10, PM 4 (Respirable), PM 5 (China Respirable), PM 2.5, PM 1 and 0.8 µm Diesel Particulate Matter (DPM). This monitor is the perfect solution for real-time, personal aerosol sampling in a variety of workplace environments, including but not limited to general industry, foundries, construction sites, chemical plants, refineries, petrochemical, power and utilities, transportation, aerospace, maritime, confined spaces and mining.



IMPACTORS

Airborne particulate matter affects each of us in numerous ways. Characterizing that particulate matter, in terms of its mass and/or chemical content, gives us insight into ambient air quality, atmospheric science, vehicle emissions, industrial particle emissions, and many more applications.

For over 30 years, MOUDI™ impactors manufactured by MSP have been widely used for collecting airborne particles in a size-segregated fashion, allowing researchers to learn more about the morphology and chemical composition of the sampled particles.

TSI's suite of cascade impactors can collect particles with aerodynamic diameters (cutpoints) from 10 nm to 10 μm , in 3 to 13 different size fractions, and at flow rates of 2, 10, 30 or 100 L/min.

To learn more about TSI's cascade impactors, take a look at individual offerings or contact a member of TSI's team today!

REAL-TIME QCM-MOUDI™ IMPACTOR

Model QCM MOUDI 140

The QCM-MOUDI™ has a 2.5- μm inlet and six stages with sharp collection efficiency curves and calibrated cutpoints of 960, 510, 305, 156, 74 and 45 nm at 10-L/min inlet flow rate. The QCM-MOUDI provides excellent mass measurement accuracy thanks to the integrated humidity conditioning system that ensures reliable coupling of aerosol particles to the quartz crystal sensors, and eliminates undesirable solid particle bounce. With the QCM-MOUDI, setup and measurement time has gone from hours to minutes allowing the user to collect size fractionated aerosol masses, in real time (1 Hz data collection), from tens of nanograms up to a few hundred micrograms.

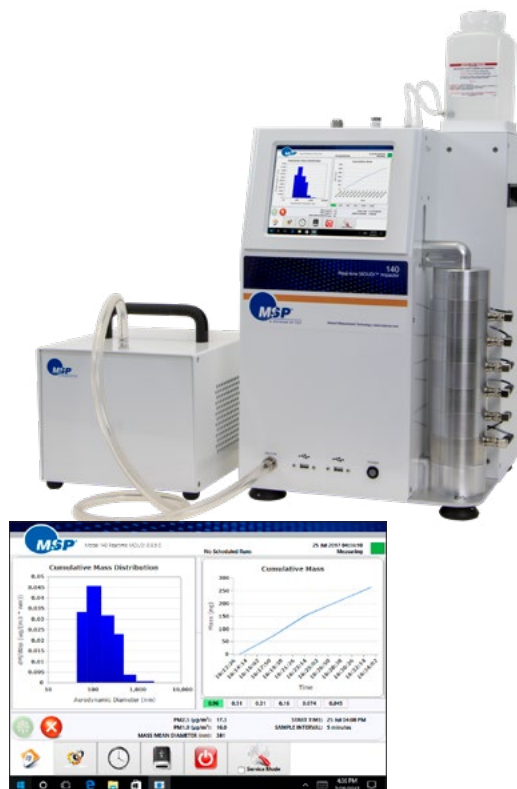

Accessories (Available separately):

Specify	Description
140-HFSS	High Flow Sampling System
0140-01-1010	Impactor Stack, QCM MOUDI, 6 stages
0140-98-1308	Replacement QCM Crystal/Plate
3334-10	Diluter
3334-100	Diluter

MOUDI™ NON-ROTATING IMPACTORS

Model MOUDI 100NR, 100S4, 110NR

MOUDI™ non-rotating impactors are classic, precise cascade impactors with sharp cut-sizes and low internal losses. These impactors are used for collecting size-fractionated particle samples in the 0.056 to 10 µm aerodynamic diameter range with a 30-L/min sampling flow rate. Particle deposits are collected on standard 47-mm substrates which can be analyzed for mass, chemical composition or by microscopy.

Model	Stages	Nominal Cut Points (µm)	Flow Rate (L/min)	Pressure Drop (kPa)
100S4	3	10, 2.5 and 1.0	30	1
100NR	8	10, 5.6, 3.2, 1.8, 1.0, 0.56, 0.32, and 0.18	30	10
110NR	10	10, 5.6, 3.2, 1.8, 1.0, 0.56, 0.32, 0.18, 0.10, and 0.056	30	40



Accessories (Available separately):

Specify	Description
0100-01-1050	Vacuum Pump, 100/110, 110V
0100-01-1051	Vacuum Pump, 100/110, 220V, EU
0100-01-1052	Vacuum Pump, 100/110, 220V, UK
0100-01-0079	Vacuum Pump, 100S4, 110V
0100-47-AF	Al Foil Substrates, 47 mm, Pkg. 300
0001-01-9953	Glass Fiber Filters, 47 mm, Pkg. 100
0001-01-5024	Quartz Fiber Filters, 47 mm, Pkg. 100
0100-01-0100	Silicone Impactor Surface Spray
0100-96-0558	Silicone Lubricating Grease, 5.3 oz

Model Mini MOUDI 135

Mini-MOUDI™ 135 impactors are high-accuracy impactors with a low sampling flow rate and a small physical size. They are available with 6, 8, and 10 impaction stages to provide size-fractionated particle samples.

Mini-MOUDI Model 135 impactors are used for personal exposure sampling and for unique applications such as characterizing e-cigarette smoke. Particle deposits are collected on 37 mm semicircular aluminum substrates.

Model	Stages	Nominal Cut Points (µm)	Flow Rate (L/min)	Pressure Drop (kPa)
135-6	6	10, 5.6, 3.2, 1.8, 1.0, and 0.56	2	1
135-8	8	10, 5.6, 3.2, 1.8, 1.0, 0.56, 0.32, and 0.18	2	10
135-10	10	10, 5.6, 3.2, 1.8, 1.0, 0.56, 0.32, 0.18, 0.10, and 0.056	2	40



Accessories (Available separately):

Specify	Description
0135-75-5007	Vacuum Pump, 135-6,135-8, 110V charger
0135-75-5008	Vacuum Pump, 135-6,135-8, 220V charger
0135-01-0100	Vacuum Pump, 135-10, 110V
0135-01-0101	Vacuum Pump, 135-10, 220V, EU
0135-01-0102	Vacuum Pump, 135-10, 220V, UK
0135-01-0014-AF	Al Foil Substrates, Pkg 300
0135-01-5203	Glass Fiber Filters, 37-mm, Pkg 100

MOUDI™-II ROTATING IMPACTORS

Models 120R, 122R, 125R

MOUDI™-II and NanoMOUDI-II impactors are second generation Micro-Orifice, Uniform-Deposit Impactors from TSI. These impactors are noted for their superior aerodynamic design, sharp cut-size, and low particle loss characteristics. Up to 6000 precision micro-orifice nozzles are used to reduce pressure drop, jet velocity, particle bounce, and re-entrainment.

MOUDI-II impactors allow users to sample for days thanks to the reliable internal impaction plate rotation. Sampling flow rates are 30 L/min for the models 120 and 122, and 10 L/min for the model 125. The nominal cut-size aerodynamic diameter range is 10 nm to 10 µm. MOUDI-II impactors can be operated remotely through an Ethernet connection.

Model	Stages	Nominal Cut Points (µm)	Flow Rate (L/min)	Pressure Drop (kPa)
120R	10	10, 5.6, 3.2, 1.8, 1.0, 0.56, 0.32, 0.18, 0.10, and 0.056	30	40
122R	13	10, 5.6, 3.2, 1.8, 1.0, 0.56, 0.32, 0.18, 0.10, 0.056, 0.032, 0.018 and 0.010	30	90
125R	13	10, 5.6, 3.2, 1.8, 1.0, 0.56, 0.32, 0.18, 0.10, 0.056, 0.032, 0.018 and 0.010	10	90



Accessories (Available separately):

Specify	Description
0120-98-1051	Vacuum Pump, 120R, 110V
0120-98-1050	Vacuum Pump, 120R, 220V
0122-01-2016	Vacuum Pump, 122R, 230V, EU
0122-01-2011	Vacuum Pump, 122R, 230V, US
0125-98-0100	Vacuum Pump, 125R, 110V
0125-98-0101	Vacuum Pump, 125R, 220V
0130-75-AF	Al Foil Substrates, 47mm, Pkg. 300
0122-90-AF	Al Foil Substrates, 90mm, Pkg. 100
0001-01-9953	Glass Fiber Filters, 47mm, Pkg. 100
0001-01-5024	Quartz Fiber Filters, 47mm, Pkg. 100
0130-01-5010	Glass Fiber Filters, 90mm, Pkg. 100
0100-01-0100	Silicone Impactor Surface Spray
0100-96-0558	Silicone Lubricating Grease, 5.3 oz.

HIGH FLOW IMPACTORS

Models 128, 129, 130, 131

High Flow Impactors (HFI) are ideal for sampling particles at low concentrations, for obtaining samples in short sampling intervals, or for collecting more mass per stage as compared to more conventional medium flow rate impactors. HFI impactors are available with 3, 4, 5 or 6 stages in the 0.25 to 10 µm aerodynamic size range. HFI impactors sample at a high flow rate with a low flow resistance. Particle deposits are collected on 75-mm substrates which can be analyzed for mass, or via chemical analysis or microscopy.

Model	Stages	Nominal Cut Points (µm)	Flow Rate (L/min)	Pressure Drop (kPa)
128	3	10, 2.5 and 1.0	100	0.6
129	4	10, 2.5, 1.0, and 0.25	100	5
130A	5	2.5, 1.4, 0.77, 0.44 and 0.25	100	6
130B	5	2.5, 1.4, 1.0, 0.44 and 0.25	100	6
131A	6	10, 2.5, 1.4, 0.77, 0.44 and 0.25	100	6
131B	6	10, 2.5, 1.4, 1.0, 0.44 and 0.25	100	6



Accessories (Available separately):

Specify	Description
0130-01-1051	Vacuum Pump, 128-131, 110V
0130-01-1050	Vacuum Pump, 128-131, 220V, EU
0130-01-1050	Vacuum Pump, 128-131, 220V, UK
0130-75-AF	Al Foil Substrates, 75 mm, Pkg. 300
0130-01-5010	Glass Fiber Filters, 90 mm, Pkg. 100
0100-01-0100	Silicone Impactor Surface Spray
0100-96-0558	Silicone Lubricating Grease, 5.3 oz

AEROSOL GENERATORS AND DISPERSERS

Collectively, our generators and dispersers produce particles in the range of 0.002 to 200 micrometers from liquids, suspensions or powders.

Visit <http://www.tsi.com/aerosol-generators-and-dispersers/> for the full overview.

MONODISPERSE GENERATORS

This type of generators is useful anywhere a precise, monodisperse aerosol is needed. Specific applications include calibrating particle counters, testing various filters, and studying size-dependent particle properties.

Model	3482	3940A and 3082	3475	1520
Particle size range (μm)	<0.002 to >0.15	0.001 to 1.0	0.1 to 8.0	0.8 to 12 μm
Particle concentration (particles/ cm^3)	>10 ⁷	<10 ⁵	>10 ⁶	< 3,000
Nominal flow rate (L/min)	0.2 to 2.5	0.2 to 3.5	3.5 to 4	5 to 25 L/min

ELECTROSPRAY AEROSOL GENERATOR

Model 3482

Produces monodisperse particles as small as 2 nanometers.

The Electro Spray Aerosol Generator (EAG) uses a patented technique to produce high concentrations of monodisperse, submicrometer particles in the range from 2 to >100 nm in diameter. The EAG produces such small, uniform particles by pushing a charged liquid solution or suspension through a capillary tube and exerting an electrical field on the liquid at the capillary tip. The electrical field pulls the liquid from the capillary, forming individual droplets. Air and CO₂ mixed with the droplets evaporate the liquid, and the remaining particles are neutralized by an ionizer. The result is a neutralized, monodisperse aerosol. Applications for the EAG include instrument calibration, nanometer-sized powder dispersion, macromolecular analysis, and nano-aerosol studies.



The 3482 electro spray produces particles down to 2 nm. The camera and viewing screen allows you to easily see the capillary tip during operation: (1) no liquid flow; (2) with liquid flow but no electric field; (3) with liquid flow and electric field (showing the formation of the Taylor cone).

Accessories (Available separately):

Specify	Description
3482-SPUMP	Syringe Pump

SUBMICROMETER MONODISPERSE AEROSOL GENERATION SYSTEM

Model 3940A

A complete system for generating monodisperse, submicrometer particles.

The Submicrometer Monodisperse Aerosol Generation System gives you the ability to produce monodisperse particles from 0.01 to 1.0 μm in diameter. The system includes:

- + 3082 Electrostatic Classifier Platform
- + 3081A Long DMA
- + 3077A Aerosol Neutralizer
- + 3012 Aerosol Neutralizer
- + 3074B Filtered Air Supply
- + 3076 Constant Output Atomizer
- + 3062 Diffusion Dryer
- + 1035575 Dilution Bridge



ELECTROSTATIC CLASSIFIERS

Model 3082

Primary-standard instruments that produce highly monodisperse, submicrometer aerosols.

The Series 3082 Electrostatic Classifiers are primary-standard aerosol instruments that give you highly monodisperse, submicrometer aerosol from a polydisperse source. Our classifiers have been used in a variety of aerosol-generation or particle-sizing applications with highly repeatable results.

Electrostatic Classifiers neutralize polydisperse aerosol and use a differential mobility analyzer (DMA) to classify and strip out a narrow, predictable size. TSI provides a choice of three DMA columns. You can purchase any column and interchange them on the same platform, giving you unprecedented versatility. The platform is available separately for use with your own DMA.

Particles produced with our Electrostatic Classifiers range in size from 0.001 to 1.0 μm . For monodisperse aerosol generation, simply set the software for the desired particle size.

Electrostatic Classifiers

3082	Classifier Platform
3081A	Long DMA (0.01 to 1 μm)
3085A	Nano DMA (0.002 to 0.15 μm)
3086	1 nm-DMA (1 to 50 nm)



Electrostatic Classifiers are included in our SMPS™ systems. Model 3082 and 3081A is part of the Model 3940A Submicrometer Monodisperse Aerosol Generation System. DMA columns are interchangeable. For restrictions, consult local authorities on the use of Aerosol Neutralizers. The Nano DMA was developed in cooperation with the University of Minnesota Particle Technology Laboratory and Gerhard Mercator University. Refer to United States Patent Number 6,230,572.

Accessories (available separately):

Specify	Description
3077	Aerosol Neutralizer
3077A	Aerosol Neutralizer
3088	Advanced Aerosol Neutralizer
6005931	Lead Shielding Column

Upgrade your old SMPS (model series 3936)

In 2013, TSI made significant improvements to the SMPS - contact us to learn about the advantages

3082-UPGRADE-L	Upgrade a 3080 Classifier and 3081 DMA
3082-UPGRADE-N	Upgrade a 3080 Classifier and 3085 DMA
3082-UPGRADE-L-DP	Upgrade a 3080 and 3081 DMA Dual Polarity
3082-UPGRADE-N-DP	Upgrade a 3080 and 3085 DMA Dual Polarity

CONDENSATION MONODISPERSE AEROSOL GENERATOR

Model 3475

Generates high-concentration, monodisperse aerosols quickly and accurately.

The Condensation Monodisperse Aerosol Generator (CMAG) is a condensation-type instrument that produces high-concentration, monodisperse aerosol particles. It is well-suited for challenging HEPA and ULPA filters, seeding wind tunnels, conducting inhalation studies, or other applications requiring monodisperse particles in high concentrations.

The CMAG generates liquid or solid particles from a variety of oils, waxes, and other materials, in concentrations greater than 10^6 particles/cm³. It generates monodisperse particles in the range of 0.1 to 8 μ m and operates at a flow rate of 3.5 to 4 L/min. Particles can be fluorescently or radioactively labeled. A coil heater inside the saturator and a condensation-nuclei bypass filter provide rapid response when changing aerosol size. The CMAG can operate for long periods without interruption. Aerosol may be monitored for size and concentration using the optional Process Aerosol Monitor.

Please specify voltage requirements. Models 3475 and 3375 are produced in Germany by Topas GmbH.



CMAG Accessories (available separately):

Specify	Description
3375	Process Aerosol Monitor

PROCESS AEROSOL MONITOR

Model 3375

Monitors high-concentration, monodisperse aerosols.

The Process Aerosol Monitor (PAM) measures high-concentration, monodisperse aerosols like those produced by our Model 3475 Condensation Monodisperse Aerosol Generator (CMAG) or other Sinclair-LaMer-type generators. It monitors aerosols on-line, measuring particle size and concentration in real time.

Please specify voltage requirements. Models 3475 and 3375 are produced in Germany by Topas GmbH.



FLOW-FOCUSING MONODISPERSE AEROSOL GENERATOR

Model 1520

Produces monodisperse droplets and aerosol particles.

The Flow-Focusing Monodisperse Aerosol Generator (FMAG 1520) uses the aerodynamic flow-focusing effect to accurately control the diameter of a liquid jet for generating monodisperse droplets from 15 - 90 μm in diameter, which are then dried to produce particles from 0.8 to 12 μm in diameter. In normal operation, a stream of liquid flowing out of a 100- μm -diameter nozzle is stretched to a much thinner stream by the focusing gas flow. The resulting thin liquid jet then breaks up into uniform-sized droplets after passing through a vibrating ceramic aerosol generation head. The large 100- μm -diameter nozzle in the FMAG enables aerosol generation over extended periods of time without experiencing nozzle clogging problems, and at a very low liquid pressure. This low shear stress generally enables biological cells to remain viable, even after dispersion as uniform particles.



POLYDISPERSE GENERATORS

This type of generator is typically capable of spraying aqueous solutions (e.g. salt), suspensions (e.g. PSL, nanoparticles), or oil or similar substances. They serve a variety of applications from laboratory research field tests of detectors, and filter testing.

Model	3073	3079A	3076	9302/6	8108	2045	2045S
Particle size range (μm)	0.01 to 2.0 (nominal 0.3 count mean diameter)				0.1 to 10	0.1 to 1.0 (PSL spheres)	0.4 to 0.7 (MMAD) (corn oil)
Particle concentration (particles/ cm^3) or Output	100 to $>10^7$	$>10^9$	$>10^7$	$>10^7$	$<1,000$ at 1 μm	7.2×10^{10} PSL/minute at 0.12 μm	0.08 to 0.20 g/min (corn oil)
Nominal flow rate (L/min)	0.3 to 4.5	1.0 to 4.2	~ 3.0	6.5 to 1,000	140	80 to 250	80 to 250
Note	Portable with battery option	Portable	Laboratory grade	High output	Designed for ISO 16890-2 filter testing	High PSL output for HEPA/ULPA filter testing	Corn oil aerosol for respirator testing

PORTABLE TEST AEROSOL GENERATOR

Model 3073

A high-end test aerosol generator for low and high concentration polydisperse droplet aerosols. It generates submicron aerosols from oils, and from salt or PSL solutions. The innovative new flow control reduces power consumption and achieves highly stable low particle production rates, ideal for calibration of particle sizing instruments. Its compact and lightweight design coupled with battery operation make it a perfect fit for use in field test applications.





PORTABLE ATOMIZER

Model 3079A

This rugged, compact atomizer generates particles in concentrations over 10^8 particles/cm³ and offers an adjustable flow rate from 1.0 to 4.2 L/min. A built-in, low-noise compressor provides compressed air, and the atomizer head is made entirely of stainless steel. Operating components are protected by a hood, making this atomizer highly portable and suitable for acceptance tests.

SINGLE-JET ATOMIZER

Model 9302

Our simplest atomizer includes a built-in pressure regulator for controlling air from an external source. It produces particles in concentrations over 10^7 particles/cm³ at a nominal flow rate of 6.5 L/min.

CONSTANT OUTPUT ATOMIZER

Model 3076

Generates aerosols of constant particle size in concentrations over 10^7 particles/cm³ (nominal). Its nominal aerosol flow rate is 3.0 to 3.5 L/min. Stainless steel components make this Collison-type atomizer suitable for biological and medical research, material synthesis, filter testing, instrument calibration, and basic research.

SIX-JET ATOMIZER

Model 9306

Features the highest flow rate of any TSI atomizer and a built-in dilution system. Users may select up to six jets, each producing particle concentrations greater than 10^7 particles/cm³ at 6.5 L/min (nominal at 25 psig pressure). Built-in dilution air controlled by a valve and rotameter allows you to vary the output particle concentration.

All four atomizers produce a mean droplet diameter of 0.3 μ m with a geometric standard deviation of less than 2.0. They are suitable for work with a wide range of solutions and suspensions, including polystyrene latex (PSL) spheres, dioctyl phthalate (DOP), silicon oil, salt or sugar solutions, and methylene blue.

LARGE-PARTICLE AEROSOL GENERATOR

Model 8108

Generates high-concentration aerosols up to 10 µm in diameter.

The Large-Particle Aerosol Generator produces highly concentrated aerosol over a wide particle-size range, from 0.1 to 10 µm. Designed for easy cleaning, this generator produces potassium chloride (KCl) and other aerosols. Model 8108 meets the requirements of ASHRAE 52.2 and can also be used for ISO/TS 11155-1:2001 filter efficiency testing. It's an ideal aerosol generator for fractional efficiency testing of general ventilation filters and automotive cabin-air filters.



HIGH OUTPUT PSL AEROSOL GENERATOR

Model 2045

The High Output PSL Aerosol Generator 2045 designed for particle penetration and leak/integrity testing of HEPA/ULPA cleanroom filters using non-contaminating, solid PSL spheres instead of contaminating oils such as DOP and PAO. This is of particular importance when testing filters for the semiconductor, pharmaceutical and medical device industries.

The High Output PSL Aerosol Generator produces 1×10^8 PSL spheres per cubic foot when injected into 720 cfm of air flow for testing 24"x48" (61cm x 122cm) filters at 90 ft/min (0.46 m/s) face velocity, sufficient to produce a downstream concentration of 100 particles/ft³ (3.5 particles/L) for a six-nine efficiency (99.9999%) ULPA filter.



HIGH OUTPUT CORN OIL AEROSOL GENERATOR

Model 2045S

The High Output Corn Oil Aerosol Generator 2045S designed for particle penetration and leak/integrity testing of respirators for chemical, biological, radiological and nuclear aerosol protection (NIOSH Procedure No. CET-APRS-STP-CBRN-0452, September 22, 2005).

Model 2045S is equipped with an impactor at the exit of the generator to reduce the mass median diameter of the aerosol generated.



POWDER DISPERSERS

This type of generators disperse dry dust and powders for applications that need continuous and stable dosing with high accuracy. These defined test aerosols are commonly used in aerosol science, filter testing, industrial processes, and quality assurance tasks. Powder dispersion does not always achieve full deagglomeration.

Model	3410U	3410L	3400A
Particle size range (µm)	0.2 to >100	0.2 to >100	0.5 to 40
Particle mass concentration	50 mg/m ³ to 20 g/m ³	0.5 to 20 g/m ³	10 - 100 mg/m ³
Nominal flow rate (L/min)	8 to 35	25 to 67	5 to 15
Note	Refill during operation. Cover to keep dust dry. Modular.		Not available in countries with RoHS requirements

FLUIDIZED BED AEROSOL GENERATOR

Model 3400A

Disperses powders in stable concentrations for dust experiments or particle seeding.

The Fluidized Bed Aerosol Generator (FBAG) is our general-purpose powder disperser. It prepares any dry, free-flowing powder for dispersion in a gas. It disperses powders that range from 0.5 to 40 µm, with concentrations from 10 to 100 mg/m³. Unsurpassed constant output and concentration make the FBAG useful for inhalation toxicology studies, laser-velocimeter seeding, and filter testing.



Not available in countries with RoHS requirements.

Accessories (Available separately):

Specify	Description
3012	Aerosol Neutralizer
3074B	Filtered Air Supply
1502574	Replacement bronze beads

DUST AEROSOL GENERATOR

Model 3410

The Dust Aerosol Generator Model 3410 comes in two versions that differ in the way the powder is fed to the disperser.

The Dust Aerosol Generator Model 3410 disperses dry dust and powders for applications that need continuous and stable dosing with high accuracy. The interchangeable dispersing units make it possible to disperse different materials (e.g. soot, TiO₂, cellulose, or ISO 12103 test dust) at different output concentrations. A pressurized cover keeps the material dry even in locations with higher ambient humidity.

Both versions disperse the powder via an ejector nozzle with ceramic inlay to make it more resistant against abrasive material. Shear forces in the ejector nozzle disperse and de-agglomerate particles. In both models the reservoir can be refilled while in operation to accommodate any required dosing interval.

Model 3410U is for poorly flowing powders at low dosing rates (>50 mg/m³). Here the powder is continually poured onto a metal ring where excess material falls off the side and back into the reservoir.



Model 3410L meters powder using a moving toothed belt. The well-defined spaces between the teeth ensure a constant and reproducible supply of powder and achieve mass concentrations of 0.5 to 160 g/m³.

Accessories (Available separately):

Specify	Description
3074B	Filtered Air Supply
3413U	Full Enclosure (includes 3410U generator)
3413L	Full Enclosure (includes 3410L generator)
3411	Remote Control (for 3410U, 3410L, 3413U, and 3413L)
3410-DISL	Model L dispersion unit for 3410U
3410-DISU	Model U dispersion unit for 3410L
1602051	HEPA capsule filter

SEED AEROSOL GENERATORS

This type of generators is specifically designed to generate particles in droplet and solid forms. The generators can be used to disperse various types of matter, including water droplets, salt or sugar particles, polystyrene latex particles and oil droplets. They serve a variety of applications from laboratory research, filter testing and flow velocity measurements.

**Models 9302 and 9306 listed on page 30

Model	9302**	9306**	9307	9307-6	9308	9309
Solid particle Size range (μm)	0.5 to 5 μm (salt of sugar) and 0.5 to 4 μm (PSL)					0.2 to 3 μm (SiO_2 , Al_2O_3 , TiO, powder)
Aerosol concentration ($1/\text{cm}^3$)	>10 ⁷					
Nominal flow rate (L/min)	2.4 to 12	14.4 to 72	30	1000	0.063	Adjustable pressure up to 16 bar
Note	Single-jet atomizer	Six-jet atomizer	Single-jet Laskin nozzle	Six-jet Laskin nozzle	Fog generator	Fluidized bed

OIL DROPLET GENERATOR

Model 9307

Generates large quantities of oil droplets for seeding.

Laskin nozzle oil droplet generator models 9307 (single-jet) is designed to generate large amounts of seed particles for the seeding of PIV or LDV flows. It is also ideal for seeding in high-speed flows for wind tunnel experiments.

This generator is typically used with olive oil, but can also be used with other fluids such as DEHS or salt solutions (for aerosolizing solid salt particles).



SEED PARTICLE GENERATOR

Model 9307-6

TSI's Model 9307-6 is a general purpose atomizer that uses a Laskin nozzle to produce large quantities of oil or salt particles. An internal impactor plate helps to generate particles with a reasonably narrow size distribution, while a valve and pressure gauge arrangement provides an easy way to control inlet air pressure, allowing for larger particle output volume if necessary.



FOG GENERATOR

Model 9308

Fog generator model 9308 offers high output and remarkable flexibility in a compact, easy-to-transport unit. The volume control feature allows users to release the right amount of fog, ranging from small wisps to large clouds, for just about any situation. Model 9308 is controlled through a control panel that serves as either the remote or on-board control, and is connected to the machine with a standard 7 pin XLR connector.



SOLID PARTICLE GENERATOR

Model 9309

Solid seed particle generator model 9309 is ideal for dispersing solid particles in order to seed flow fields in high pressure or high temperature environments, like combustion in open flames. This generator uses SiO_2 , TiO_2 , and Al_2O_3 dry powders. The generator is designed to be operated at high pressures and it must be kept dry in order for the powders to disperse properly.



INSTRUMENTS & ACCESSORIES

NANOMETER AEROSOL SAMPLER

Model 3089

Deposits 2- to 100 nm particles on TEM grids, AFM substrates or glass slides.

The Nanometer Aerosol Sampler (NAS) allows you to sample charged particles, like those from the output of a Differential Mobility Analyzer (DMA), onto sample substrates for analysis. You control the spot size of the deposition using two electrode sizes and get a uniform deposition spot size that is optimal for your analysis system. (Not sold in Europe)



FLOW CALIBRATOR

Model 4148 & 4048

TSI Flow Calibrators are small, simple and portable flow measuring devices. A low pressure drop minimizes the impact on your experiments.

These easy-to-read, handheld units can be powered through the included battery pack or via the included universal power supply allowing for portable benchtop use. The volumetric flow rate is continuously displayed allowing for fast and easy confirmation of the inlet flow displayed on the unit. The flow calibrators are temperature-compensated and pressure-corrected allowing calculated volumetric flow readings to have an accuracy of $\pm 2\%$ of reading. An in-line HEPA filter is included to protect the flowmeter from particles in the aerosol sample and help maintain calibration.

Model 4148 operates from 0 to 20 L/min and has barb fittings for 1/4" tubing.

Model 4048 operates from 0 to 200 L/min and has barb fittings for 3/8" tubing. Both models are calibrated for air.



DIFFUSION DRYER

Model 3062 & 3062-NC

Removes moisture from sample aerosols.

Our Diffusion Dryer includes a removable extractor for collecting large water droplets. Desiccant surrounding the aerosol flow path removes excess moisture by diffusional capture. Because aerosol never comes in contact with the desiccant, there is minimal particle loss. Regenerate the desiccant simply by removing it from the Diffusion Dryer and baking it at 120°C. Maximum flow rate is 4 L/min. The -NC version has identical specifications, but no cobalt.



RADIOACTIVE AEROSOL NEUTRALIZERS*

Models 3012, 3054, 3077 & 348002

Minimize particle losses and coagulation by electrostatic charges, or charge particles properly for size analysis or air-filter measurements.

Aerosol particles dispersed by nebulization, combustion, or powder dispersion are usually electrostatically charged and are subject to high losses during transport. To reduce transport losses and ensure that instruments operating on the electrostatic principle work properly, particles must be neutralized. These Aerosol Neutralizers use a radioactive source (⁶⁵Kr or ²¹⁰Po) to perform this function. The radioactive source ionizes the surrounding atmosphere creating positive and negative ions. Particles carrying a high charge can discharge by interacting with ions of opposite polarity. After a short time, the particles reach charge equilibrium. TSI recommends models 3012A, 3054A, or 3077A for aerosols with higher charge levels or when operating at higher flow rates or high concentration.



Radioactive Aerosol Neutralizers

- 3012 For general-purpose applications with high flow rates (up to 50 L/min), 2 mCi, 74 MBq
- 3012A Same as above, but with five times the activity (10 mCi, 370 MBq)
- 3054 Suitable for high flow rate applications (up to 150 L/min), 10 mCi, 370 MBq
- 3054A Same as above, but with twice the activity (20 mCi, 740 MBq)
- 3077 For general-purpose applications with low flow rates (up to 5 L/min); standard with Series 3936 Scanning Mobility Particle Sizer™ spectrometers. 2 mCi, 74 MBq
- 3077A Same as above, but with five times the activity (10 mCi, 370 MBq)
- 348002 Included with Model 3480 Electro Spray Aerosol Generator, Po-210 source. 5 mCi, 185 MBq

NON-RADIOACTIVE AEROSOL NEUTRALIZERS

Model 3088

The TSI Advanced Aerosol Neutralizer Model 3088 offers an alternative to traditional radioactive neutralizers frequently required for aerosol measurement applications. Due to increasingly stringent local, state and national regulations, obtaining licensing to acquire and use radioactive sources is often difficult and in some cases prohibited. Fully compliant with US FDA, CDRH* standards, the patented Model 3088 provides an attractive alternative, with sizing performance virtually identical to TSI's Aerosol Neutralizer Model 3077A.

The 3088 is compatible with TSI's SMPS spectrometers Models 3938, 3936 and 3034, and Electrostatic Classifiers Models 3082 and 3080. It has a bipolar diffusion charger to balance positive and negative ions, neutralizes particles up to 10⁷ particles/cm³, and does not generate particles. Its maximum design flow rate is 5 L/min.

*Provide end-user name and address when ordering Aerosol Neutralizers. TSI has been issued license number 1154-200-62 by the Minnesota Department of Health to sell and distribute these Aerosol Neutralizers. Users in the United States need not apply for additional U.S. Government licenses to handle these products. However, some state and local governments may require special licenses, and some organizations may have special handling procedures. Check all local requirements.

ELECTRICAL NEUTRALIZER

Model 1090

The Model 1090 Electrical Neutralizer is an aerosol charge conditioner for conditioning the electrical charge on aerosol particles to a Boltzmann equilibrium charge equivalent to that produced by a radioactive ionizer, but without the use of radioactivity. The Model 1090 uses both positive and negative ions to condition the particles, and does not generate contaminant particles. The Model 1090 can operate at flow rates from 0.5 - 2.5 L/min.



FILTERED AIR SUPPLY

Model 3074B

Cleans, dries, and regulates compressed air for aerosol generation and other applications.

The Filtered Air Supply removes oil or other liquid droplets from the incoming air using two prefilters. It also removes any remaining moisture in the air stream by passing the air through an advanced membrane dryer (no more drying of desiccant material!). Plus, it removes fine particles using a high-efficiency filter at the outlet. This full-featured compressed-air conditioner allows you to make pressure adjustments using an included gas-regulator valve. It handles a maximum flow rate of 60 L/min at a dewpoint as low as 2°C. Maximum inlet pressure is 1,000 kPa (150 psig).



FLOW SPLITTER

Model 3708

Routes sample from one source to several instruments.

The Flow Splitter directs an aerosol sample to as many as four destinations at once. Need only two or three flow paths? Then simply block the unused outlet ports. This accessory is especially useful when performing instrument comparison or calibration experiments. Smooth flow transitions provide equal flow distribution. Stainless-steel construction and an electropolished interior prevent the aerosol from being contaminated. The Flow Splitter has a 3/8-inch straight-tube inlet and four 1/4-inch outlets (outside diameters). Maximum total flow rate is 30 L/min.



PARTICLE SIZE SELECTOR

Model 376060

Allows selection of different cutoff sizes for CPCs.

The Particle Size Selector (PSS) allows you to control the lower size cutoff of a TSI Condensation Particle Counter (CPC). The PSS is a separating device that selectively removes small particles from an aerosol by diffusion. Simply add or remove diffusion screens to change the lower cutoff size. The cutoff shifts toward larger sizes as more screens are added.

The PSS includes 11 screens and, therefore, can be configured for 11 cutoff sizes. An extra set of 12 screens may be ordered to expand the cutoff range further. Specific cutoff sizes vary based on CPC operating flow rate.



The technique of using a Condensation Particle Counter with diffusion screens to select specific particle size ranges is covered in United States Patent Number 5,072,626.

PSS Accessory (Available separately):

Specify	Description
376061	Set of 12 additional diffusion screens

VACUUM PUMPS

Models 3032/3033

Use these top-quality pumps when you need a portable vacuum source.

Model 3032 is a diaphragm-type pump that produces flow rates up to 5 L/min. Oversized, permanently lubricated bearings promote longer life and maintenance-free operation. The pump operates in any position. We offer this small, reliable pump for use with our Model 3790A, 3783, and 3750 Condensation Particle Counters, or Series 3938 Scanning Mobility Particle Sizer™ spectrometers containing a 3750 CPC.

Model 3033 produces flows up to 60 L/min. This high-quality, rotary-vane pump contains self-sealing, compound-carbon vanes that self-adjust as they wear. Therefore, it always operates at top efficiency. Permanently lubricated ball bearings make the 3033 virtually maintenance-free. This is the pump we recommend for use with our Model 3068B Aerosol Electrometer or when using multiple CPCs that require an external vacuum source. This pump is also suitable for TSI Model 3306 Impactor Inlet when used with our supermicrometer particle sizers.



Vacuum Pumps

3032	Flow rates up to 5 L/min, 115 V
3032-1	Flow rates up to 5 L/min, 230 V
3032-EC	Flow rates up to 5 L/min, 230 V (Europe only)
3033	Flow rates up to 60 L/min, 115 V (Available in voltages of 100-240VAC and 50-60 Hz)

TSI recommends these pumps only for use with specific TSI particle instruments. Please specify voltage requirements.

HIGH FLOW SAMPLING SYSTEM

Model 140-HFSS

The High Flow Sampling System (HFSS) Model 140-HFSS is an accessory designed to be used with the 140 QCM-MOUDI™ Impactor when sampling ambient air at high temperature and humidity conditions.

A Nafion® dryer can reduce the relative humidity of the sample air from as high as ~100% at 40 °C to below 80% at normal room temperature (i.e. 25°C), avoiding water condensation in the sampling line upstream of the QCM-MOUDI impactor.



TSI Incorporated serves a global market by investigating, identifying, and solving measurement problems. As an industry leader in the design and production of precision instruments, TSI partners with research institutions and customers around the world to set the standard for measurements relating to aerosol science, air flow,

health and safety, indoor air quality, fluid dynamics, and biohazard detection. With headquarters based in the U.S. and field offices throughout Europe and Asia, TSI has established a worldwide presence in the markets we serve. Every day, our dedicated employees turn research into reality.

Ordering

To order, contact your nearest representative or sales office. If you don't know which office handles your territory, then contact our corporate headquarters. Our staff will answer any questions you may have or they will put you in contact with the appropriate sales office. Contact information can also be found on the TSI website. When ordering, specify the model number, instrument name, accessory models and names, and voltage requirements.

Customer Service

TSI Customer Service Specialists are available to answer your questions about installation or operation:

US & Canada: +1 800 874 2811
UK: +44 1494 459200
Germany: +49 241 52303 0
or visit: www.tsi.com

General Information

TSI Incorporated manufactures innovative instruments for use in industry and research. The particle instruments described in this catalog represent only one of our product families. TSI offers a broad array of sensors and instrumentation systems used in a variety of measurement applications around the globe.

Headquartered in Shoreview, Minnesota, TSI has sales and representative offices all over the world. For more information on TSI particle instruments, use the contact information shown below or visit particle.tsi.com. For information on TSI instruments not discussed in this catalog, go to the main TSI web page at www.tsi.com

A sincere effort was made to ensure that all information in this catalog was current at the time of publication. However, specifications, features, and availability are subject to change. Please check with your TSI representative for the latest information. Prototype or early instruments are depicted in some photographs. Final products may vary from those pictured.

TSI, the TSI logo, Aerodynamic Particle Sizer, APS, Aerosol Instrument Manager, Engine Exhaust Particle Sizer, EEPS, Fast Mobility Particle Sizer, FMPS, Scanning Mobility Particle Sizer, SMPS, MOUDI, DustTrak and SidePak, are trademarks of TSI Incorporated.

Nafion is a registered trademark of The Chemours Company FC, LLC.

Microsoft and Windows are trademarks of Microsoft Corporation.

United States Patent Numbers 5,561,515, 7,230,431.



UNDERSTANDING, ACCELERATED

TSI Incorporated - Visit our website www.tsi.com for more information.

USA	Tel: +1 800 874 2811	India	Tel: +91 80 67877200
UK	Tel: +44 149 4 459200	China	Tel: +86 10 8219 7688
France	Tel: +33 1 41 19 21 99	Singapore	Tel: +65 6595 6388
Germany	Tel: +49 241 523030		